

Hard rigid rods on a Bethe-like lattice

Deepak Dhar

Department of Theoretical Physics, Tata Institute of Fundamental Research, Homi Bhabha Road, Mumbai 400005, India

R. Rajesh

The Institute of Mathematical Sciences, C.I.T. Campus, Taramani, Chennai 600113, India

Jürgen F. Stilck

Instituto de Física and National Institute of Science and Technology for Complex Systems, Universidade Federal Fluminense, Av. Litorânea s/n, 24210-346 Niterói, RJ, Brazil

(Received 15 February 2011; published 25 July 2011)

We study a system of long rigid rods of fixed length k with only excluded volume interaction. We show that, contrary to the general expectation, the self-consistent field equations of the Bethe approximation do not give the exact solution of the problem on the Bethe lattice in this case. We construct a new lattice, called the random locally treelike layered lattice, which allows a dense packing of rods, and we show that the Bethe self-consistent equations are exact for this lattice. For a four-coordinated lattice, k -mers with $k \geq 4$ undergo a continuous isotropic-nematic phase transition. For even coordination number $q \geq 6$, the transition exists only for $k \geq k_{\min}(q)$, and is discontinuous.

DOI: [10.1103/PhysRevE.84.011140](https://doi.org/10.1103/PhysRevE.84.011140)

PACS number(s): 64.60.Cn, 64.70.mf, 05.50.+q

I. INTRODUCTION

The study of the ordering transition in systems with only excluded volume interactions has a long history. Depending on the shape of the molecules involved, these systems can exhibit different ordered states and undergo transitions between them. Many different shapes have been studied in literature: hard spheres [1], hard squares, hexagons, triangles, tetrominoes, banana-shaped molecules [2–7], etc. In this paper, we study phase transitions in a system of hard rigid rods [8].

The hard rigid rods problem has a long history, starting with the seminal work of Onsager [9]. Onsager argued that this system would show a first-order phase transition from an isotropic to a nematic phase at sufficiently high densities, in the limit of large aspect ratio. Flory studied the hard-rods problem on a lattice [10], still allowing the rods to have continuous orientations, and using a mean-field approximation again found an isotropic-nematic transition. Zwanzig studied a system of hard rods in the continuum, but restricting rod orientations to a discrete set [11], also finding a transition to a nematic phase as the density of rods is increased with a jump in the order parameter at the transition point. The relation between continuous and discrete models is discussed in Ref. [12].

For models in continuous space of dimensions $d \geq 3$, if the aspect ratio of the rods is high enough, the existence of an isotropic-nematic transition is well accepted [8]. Our interest is in lattice models. Rods occupying k consecutive sites along any one lattice direction will be called k -mers. For dimers ($k = 2$), it can be shown rigorously that orientational correlations decay exponentially, except in the limit when all sites are occupied by rods. The exact entropy per site at full coverage can be determined for a class of periodic lattices in all dimensions [13]. In the case of full coverage, the orientational correlations have a power law tail in all dimensions $d \geq 2$ [14,15].

The question whether the lattice model of rigid rods with $k \gg 2$ undergoes a phase transition remained unsettled for a long time [16]. Recently, Ghosh and Dhar argued that k -mers on a square lattice, for $k \geq 7$, would undergo two phase transitions, and the nematic phase would exist for only an intermediate range of densities $\rho_1^* < \rho < \rho_2^*$ [17]. The first transition, from the low-density isotropic to an intermediate-density nematic phase has been studied in several recent Monte Carlo studies [18–21]. On the square lattice, the transition is found to be in the Ising [18] or equivalently in the liquid-gas universality class [22], and on the triangular and hexagonal lattices, it is in the $q = 3$ Potts model universality class [18,19]. The existence of a transition to a state with an orientational order was shown rigorously for a specific model of polydispersed hard-rod system on a two-dimensional square lattice [23]. The second transition from nematic to unordered state at ρ_2^* is much less understood. In Ref. [17], a variational estimate of the entropy of the nematic and ordered states suggests that $1 - \rho_2^*$ should vary as $1/k^2$ for large k , but not much is known about the nature of transition. Linares *et al.* estimated that $0.87 \leq \rho_2^* \leq 0.93$ for $k = 7$, and proposed an approximate functional form for the entropy as a function of the density [21].

In spite of many studies, for $k \geq 3$, there are no exact solutions known so far, except for the trivial case of one dimension. The only possible candidate solution is the case of k -mers on the Bethe lattice. We want to distinguish between the Bethe approximation (BA), considered as an *ad hoc* closure approximation scheme (the pair approximation) for the Bogolubov-Born-Green-Kirkwood-Yvon hierarchy of coupled equations [24,25], and the exact solution of a statistical mechanical model on the Bethe lattice. The BA for the problem of hard rods has already been presented in the literature [19,26]. The important difference is that an exact solution, even on a contrived lattice, ensures well-behavior conditions like the convexity of free energy. It is well known that the

BA for simple spin models, like the Ising model, becomes exact on the Bethe lattice. However, we show that the existing treatments of k -mers on the Bethe lattice are unsatisfactory. In fact, on the Bethe lattice, if the surface effects are ignored, a uniform nematic order is not possible if the coordination number is greater than four. This has led us to introduce a new lattice, to be called the random locally treelike layered (RLTL) lattice). We show that there is no difficulty in defining the high-density phase for the k -mers on the RLTL lattice, and that the Bethe's self-consistent field equations are exact on this lattice. Thus k -mers on the RLTL lattice is the only nontrivial case where the hard-rods problem for $k \geq 3$ can be solved exactly so far.

The Bethe lattice is defined as the part of a uniformly branching tree graph far away from the surface [27,28]. Given that in a uniformly branching tree, most of the sites are a finite distance from the surface, disentangling the surface contribution from that of sites deep inside requires some care [29–31]. There are some prescriptions for separating the surface contribution from bulk given in literature [32]. A rather careful and detailed discussion for the case of the Ising model on the Bethe lattice is given in Ref. [33]. One considers correlation functions deep inside a Cayley tree, whose values are independent of the boundary conditions on the surface of the tree. This can be realized for all nonzero external magnetic fields. Then thermodynamic quantities like the free energy are obtained by integrating these correlation functions with respect to the appropriate conjugate field.

Another way to realize a lattice for which the BA is exact is to work with random graphs of fixed-coordination number. One can show that in the limit when the number of sites N in the graph tends to infinity, the length of the shortest loop through a randomly picked site in the graph increases as $\ln N$ [34]. Then, the graph looks like a loopless graph of uniform coordination number, up to a distance of order $\ln N$. In the limit of large N , it looks like a Bethe lattice, except that there is no surface. This makes the study of the different models on the Bethe lattice numerically feasible [35–38]. In this case, there is no surface, but the introduction of randomness introduces frustration, and one does not get full coverage in the limit when the activity of k -mers tends to infinity. These difficulties are avoided on the RLTL lattice: the high-density phase for the k -mers is well defined and we will show that the Bethe's self-consistent field equations give the exact solution.

The rest of the paper is organized as follows. We begin with a recapitulation of the conventional treatment of the self-consistent equations for the hard-rods system on the Bethe lattice in Sec. II, and then point out the problems with this derivation. In Sec. III, we describe the RLTL lattice where every site in the lattice has the same even coordination number q . In Sec. IV, we derive the exact annealed partition function of the problem on this lattice, and show that the resulting self-consistent equations are the same as obtained earlier for the Bethe lattice. In Sec. V, we analyze the behavior of these equations for the RLTL with coordination number four, and show that it undergoes a continuous transition for $k \geq 4$. In Sec. VI, we discuss the case $q \geq 6$. We find that in this case, the system undergoes a first-order transition for $k \geq k_{\min}(q)$. Section VII contains some concluding remarks.

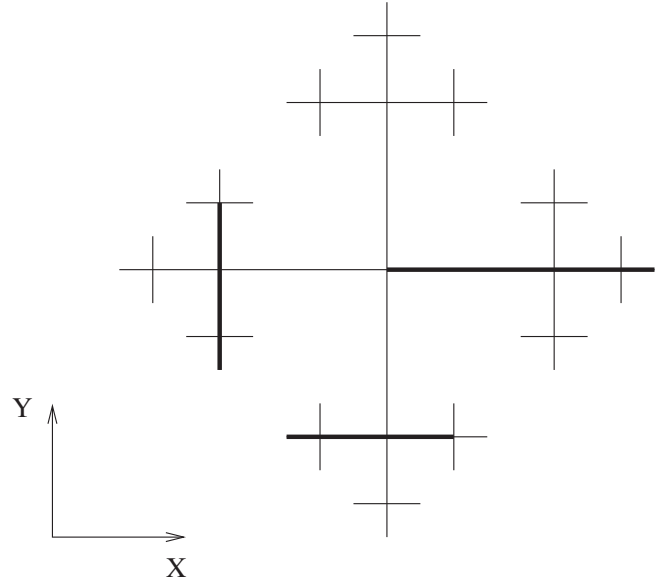

FIG. 1. A four-coordinated Cayley tree with four generations is shown. Two X-mers (horizontal thick solid lines) and one Y-mer (vertical thick solid line) with $k = 4$ are placed on the tree. The weight of the configuration is $z_1^2 z_2$.

II. k -MERS ON A four-COORDINATED BETHE LATTICE

We start with a recap of the derivation of the self-consistent equations satisfied by densities for a system of k -mers on a Bethe lattice of coordination number four. Generalization to higher even coordination numbers is straightforward. The Bethe lattice corresponds to the core of the Cayley tree with the same coordination number. The sites of the Cayley tree may be ordered by their generation, starting with $m = 0$ for the sites on the surface and ending at $m = M$ for the central site of a tree with M generations. Each site of the Cayley tree, other than those on the surface, has four bonds attached to it. Two of them will be said to be of type X and the remaining two to be of type Y. A k -mer occupies $k - 1$ consecutive bonds (and k sites) of the same type. We associate an activity z_1 with an X-type k -mer (referred to as X-mer in the following) and an activity z_2 with a Y-type k -mer (Y-mer). No two k -mers may overlap, so that each site of the lattice has at most one k -mer passing through it. Figure 1 shows a four-coordinated Cayley tree occupied by three 4-mers.

The Cayley tree is composed of four rooted subtrees that are connected to the central site. We define partial partition functions for these rooted subtrees with fixed configuration of the root bond. We specify the type and the configuration of the root bond. The root bond may be empty, or if it is occupied by a k -mer, then we specify the number of sites in earlier generations already occupied by this k -mer. There are $2k$ such partial partition functions, which we denote by $g_{x,j}$ and $g_{y,j}$, where the first subscript denotes the type of the root bond and $j = 1, \dots, k - 1$ is the number of sites that are currently part of the k -mer. $j = 0$ corresponds to the case when the root bond is empty.

The recursion relations obeyed by the partial partition functions are obtained by building a subtree with one additional generation by connecting three subtrees to a new root bond and

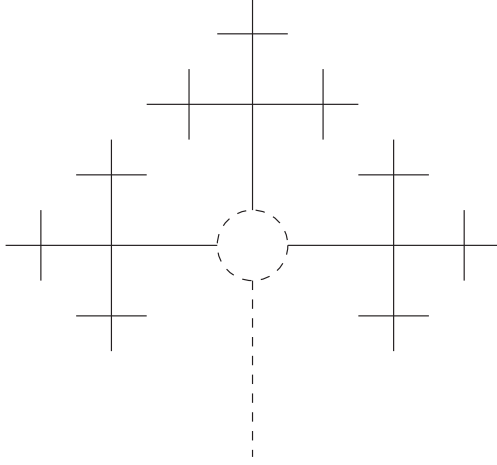

FIG. 2. Building a subtree with $M + 1 = 4$ generations of sites by connecting $q - 1 = 3$ subtrees with $M = 3$ generations of sites to a new root site and bond (denoted by dashed lines). If the root bond of the new subtree is in the Y direction, then two of the existing subtrees will have their root bond in the X direction.

new root site. This process is illustrated in Fig. 2. We attach a weight $z_1^{1/k}$ and $z_2^{1/k}$ to each occupied site of X -mer and Y -mer, respectively. The recursion relations are (see Fig. 3)

$$g'_{x,0} = (g_{x,0} + z_1^{1/k} g_{x,k-1}) g_{y,0}^2 + z_2^{1/k} g_{x,0} \sum_{j=0}^{k-1} g_{y,j} g_{x,k-1-j}, \quad (1a)$$

$$g'_{y,0} = (g_{y,0} + z_2^{1/k} g_{y,k-1}) g_{x,0}^2 + z_1^{1/k} g_{y,0} \sum_{j=0}^{k-1} g_{x,j} g_{x,k-1-j}, \quad (1b)$$

$$g'_{x,j} = z_1^{1/k} g_{x,j-1} g_{y,0}^2, \quad j = 1, \dots, k-1, \quad (1c)$$

$$g'_{y,j} = z_2^{1/k} g_{y,j-1} g_{x,0}^2, \quad j = 1, \dots, k-1, \quad (1d)$$

where the prime denotes partial partition functions of subtrees with one additional generation of sites.

The partial partition functions are multiplied by the appropriate activity each time a k -mer grows such that the weight of

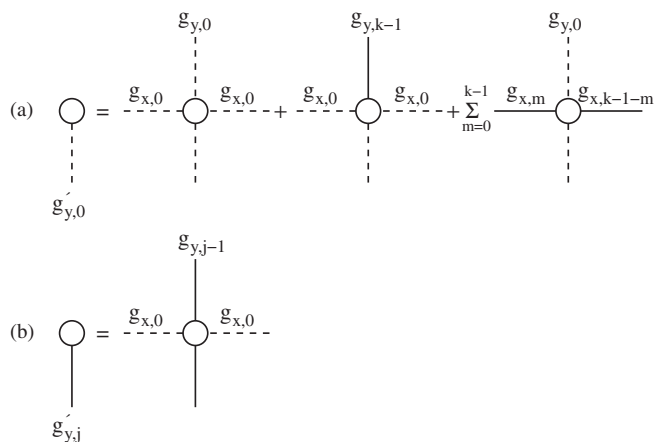

FIG. 3. Diagrammatic representation of Eq. (1) for $g'_{x,j}$, $j = 0, \dots, k-1$.

a k -mer is z_1 or z_2 depending on its type. The partial partition functions grow exponentially with the number of iterations. To calculate the densities in the core of the tree (Bethe lattice), it is useful to define ratios of partial partition functions

$$R_{i,j} = \frac{g_{i,j}}{g_{i,0}}, \quad i = x, y \quad \text{and} \quad j = 0, \dots, k-1, \quad (2)$$

such that $R_{x,0} = R_{y,0} = 1$. The recursion relations obeyed by the ratios are easily derived from Eq. (1):

$$R'_{x,j} = \frac{z_1^{1/k} R_{x,j-1}}{D_x}, \quad j = 1, \dots, k-1, \quad (3a)$$

$$R'_{y,j} = \frac{z_2^{1/k} R_{y,j-1}}{D_y}, \quad j = 1, \dots, k-1, \quad (3b)$$

where

$$D_x = 1 + z_1^{1/k} R_{x,k-1} + z_2^{1/k} \sum_{j=0}^{k-1} R_{y,j} R_{y,k-1-j}, \quad (4a)$$

$$D_y = 1 + z_2^{1/k} R_{y,k-1} + z_1^{1/k} \sum_{j=0}^{k-1} R_{x,j} R_{x,k-1-j}. \quad (4b)$$

We study the fixed points of these recursion relations. The fixed point corresponds to sites deep inside the Cayley tree, very far very far from the surface. Also, if only one single stable fixed point exists, the boundary conditions at surface sites (which determine the initial values of the recursions) have no effect on the behavior at points deep inside [30,31].

A natural choice of the starting weights for the recursion equations are such that all k -mers are completely contained within the Cayley tree. This corresponds to $g_{x,0} = g_{y,0} = 1$, $g_{x,1} = z_1^{1/k}$, and $g_{y,1} = z_2^{1/k}$, with $g_{x,j} = g_{y,j} = 0$ for all $j > 1$. However, for these choices of initial conditions the recursion relations under iteration converge to a fixed point that corresponds to the isotropic system because the initial conditions themselves are symmetric. The isotropic fixed point is stable with respect to perturbations where the initial conditions are still symmetric with respect to the two directions. However, it is unstable to asymmetric perturbations.

For surface terms that break the x - y symmetry, we find that on repeatedly iterating the recursion relations, the R 's converge to a stable fixed point R^* , which may be determined by iterating Eq. (3). Then,

$$R_{x,j}^* = \left(\frac{z_1^{1/k}}{D_x} \right)^j \equiv \alpha_x^j, \quad j = 0, \dots, k-1, \quad (5a)$$

$$R_{y,j}^* = \left(\frac{z_2^{1/k}}{D_y} \right)^j \equiv \alpha_y^j, \quad j = 0, \dots, k-1, \quad (5b)$$

where the variables α_x, α_y satisfy the equations

$$\alpha_x (1 + z_1^{1/k} \alpha_x^{k-1} + k z_2^{1/k} \alpha_y^{k-1}) = z_1^{1/k}, \quad (6a)$$

$$\alpha_y (1 + z_2^{1/k} \alpha_y^{k-1} + k z_1^{1/k} \alpha_x^{k-1}) = z_2^{1/k}. \quad (6b)$$

Knowing the fixed point solution, the density at the central site may be calculated. The grand canonical partition function of the system on the Cayley tree is given by

$$\Xi = g_{x,0}^2 g_{y,0}^2 + z_1^{1/k} g_{y,0}^2 \sum_{j=0}^{k-1} g_{x,j} g_{x,k-1-j} + z_2^{1/k} g_{x,0}^2 \sum_{j=0}^{k-1} g_{y,j} g_{y,k-1-j}. \quad (7)$$

Then, the densities ρ_x (ρ_y) of sites that are part of X-mers (Y-mers) are given by

$$\rho_x = \frac{z_1^{1/k} g_{y,0}^2 \sum_{j=0}^{k-1} g_{x,j} g_{x,k-1-j}}{\Xi}, \quad (8a)$$

$$\rho_y = \frac{z_2^{1/k} g_{x,0}^2 \sum_{j=0}^{k-1} g_{y,j} g_{y,k-1-j}}{\Xi}. \quad (8b)$$

At the fixed points, the densities simplify to

$$\rho_x = \frac{k z_1^{1/k} \alpha_x^{k-1}}{1 + k z_1^{1/k} \alpha_x^{k-1} + k z_2^{1/k} \alpha_y^{k-1}}, \quad (9a)$$

$$\rho_y = \frac{k z_2^{1/k} \alpha_y^{k-1}}{1 + k z_1^{1/k} \alpha_x^{k-1} + k z_2^{1/k} \alpha_y^{k-1}}. \quad (9b)$$

Eliminating α_x and α_y from Eqs. (9) and (6), we obtain

$$z_1(1 - \rho_x - \rho_y)^k = \frac{\rho_x}{k} \left(1 - \frac{k-1}{k} \rho_x\right)^{k-1}, \quad (10a)$$

$$z_2(1 - \rho_x - \rho_y)^k = \frac{\rho_y}{k} \left(1 - \frac{k-1}{k} \rho_y\right)^{k-1}. \quad (10b)$$

The Bethe lattice solution described above is not very satisfactory. In particular, in the limit of large z_1 and z_2 , one gets the fraction of sites occupied by k -mers tending to one. However, it is easy to see that this can only be achieved with a very special choice of boundary conditions at the surface of the tree.

Also, if we consider a tree with coordination number $q \geq 6$, then at any root vertex of a subtree, the process of exchanging the labels of different branches is clearly a symmetry operation on the lattice. The presence of this local symmetry implies that there can be no nematic order in the deep inside region, with one type of bonds preferentially occupied. Consider the case $q = 6$. Generalization to higher q is straightforward. Let the three directions be denoted as x , y , and z . We assume that the system has uniform nematic order. Then consider a site O deep inside the lattice. Let the probabilities that this is occupied by a k -mer of type x , y , or z be ρ_x , ρ_y , and ρ_z , respectively. We assume that $\rho_z > \rho_x = \rho_y$. Now consider a site O' , which is a neighbor of O in the x direction. In the subtree away from O rooted at O' , we can interchange the labels of the y and z bonds without affecting the configuration in the rest of the Bethe lattice. Therefore, at this site $\rho_z = \rho_y$. But this contradicts our assumption of uniform nematic order, and hence there can be no uniform nematic order on a Bethe lattice of coordination number ≥ 6 . This makes the Bethe lattice unsuitable for the study of isotropic-nematic transition in the hard-rod problem.

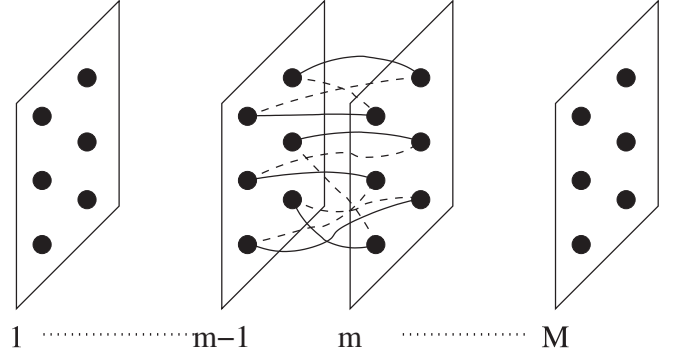

FIG. 4. Schematic diagram of the random lattice with $N = 6$ sites per layer and coordination number $q = 4$. A possible configuration of bonds between layers $m - 1$ and m is shown, with the solid and dotted lines being bonds of two different types.

III. THE RLTL LATTICE CONSTRUCTION

For simplicity, we discuss the random lattice with coordination number $q = 4$. Generalization to other coordination numbers is straightforward. We consider a set of M layers, numbered from 1 to M , with N sites in each layer. A layer m is connected to the adjacent layer $m - 1$ by N bonds of type X and N bonds of type Y. The connections are made by randomly pairing each site of the m th layers with exactly one site in the $(m - 1)$ th layer with an X bond, similarly randomly pairing each site with a site in the neighboring layer using Y bonds. The total number of such possible pairings is $(N!)^2$. This is illustrated in Fig. 4.

We can impose open or periodic boundary conditions. For a $2q$ coordinated lattice, there are $(N!)^{qM}$ different possible graphs, in the case of periodic boundary conditions (layer M is connected to layer 1), and $(N!)^{q(M-1)}$ different possible graphs for the case of open boundary conditions. We consider annealed models on this lattice, thus we average the partition function over all possible configurations of the bonds.

We can associate different degrees of freedom with the vertices, and consider statistical mechanical models on these lattices. For example, we can attach an Ising spin S_j to each vertex j of the lattice, and define the Hamiltonian to be $H = -J \sum_{mn} S_i S_j$, where the sum is over all nearest-neighbor pairs. For a particular realization \mathcal{R} of bonds, let the partition function be $\mathcal{Z}_{\mathcal{R}}(M, N)$. We average the partition function over all possible configurations of bonds. We are averaging the partition function, and not the logarithm of the partition function, this is similar to the annealed average over different bond configurations. Thus

$$Z_{\text{av}}(M, N) = \frac{1}{N_{\mathcal{R}}} \sum_{\mathcal{R}} \mathcal{Z}_{\mathcal{R}}(M, N), \quad (11)$$

where $N_{\mathcal{R}}$ is the number of different bond configurations on the lattice.

To take the thermodynamic limit, we let M and N tend to infinity. The mean free energy per site f is defined as the limit

$$f = -kT \lim_{M, N \rightarrow \infty} \frac{1}{MN} \ln Z_{\text{av}}(M, N). \quad (12)$$

We note that each site, say in layer m , has exactly one X and one Y bonds connecting it to sites in the layer $m + 1$. It can happen that these bonds fall on the same site. However, the fractional number of such cases is only $1/N$, and thus the expected number of loops of size two on this lattice is M . For even M , the graph is bipartite, and there are no loops of odd perimeter. It is easy to verify that the expected number of loops of perimeter four on this lattice is $5M$. In general, the number of loops of perimeter ℓ per site of the lattice varies as λ^ℓ/N , for $\ell \gg 1$, where λ is the self-avoiding walk growth constant on this lattice [34].

We thus see that for large N , there are very few short loops in the lattice. For a randomly picked site, the size of the shortest loop going through that site is of order $\ln N$, and this goes to infinity, as N goes to infinity. Since there are very few short loops, the structure of the lattice locally is that of a regular branching tree, and it locally looks like the Bethe lattice.

The correlation functions can be defined as usual. Consider the example of the Ising model defined above. We consider two sites i and j , and consider the two-point correlation function $\langle S_i S_j \rangle$. Since this correlation function has to be averaged over all assignments of bonds, it can depend only on the difference in layer numbers of the sites. In particular, it has the same value for all sites i and j in the same layer. Thus the expected factorization property of the correlation functions, which is the essence of the Bethe approximation, is built into the definition of the lattice.

IV. k -MERS ON THE RLTL LATTICE WITH $q = 4$

We consider a k -mer model on the RLTL lattice. A k -mer occupies $(k - 1)$ consecutive bonds of the same type. As earlier, we associate an activity z_1 with an X-mer and an activity z_2 with a Y-mer.

Let x_m be the number of X-mers with topmost (1st) site in the m th layer, and y_m is the number of Y-mers with topmost site in the m th layer. We will denote by X_m and Y_m , the number of sites in the m th layer occupied by X type and Y type bonds, respectively, but where the site is not the topmost site of the k -mer. Clearly, we have

$$X_m = \sum_{j=1}^{k-1} x_{m-j}, \quad Y_m = \sum_{j=1}^{k-1} y_{m-j}. \quad (13)$$

We can adopt the convention that $x_m = y_m = 0$, for $m \leq 0$. Then the above equation holds for all $m, 1 \leq m \leq M$. Note that if we want the k -mers to be fully contained in the lattice (with open boundary conditions), we must also have $x_m = y_m = 0$, for $m \geq M - k + 2$.

To calculate the partition function, consider the operation of adding an additional layer. We thus specify the full set of $2M$ values $\{x_m, y_m\}$ for all m . The total statistical weight of configurations that contribute to a particular set $\{x_m, y_m\}$ will be denoted by $C(\{x_m, y_m\})$.

We calculate $C(\{x_m, y_m\})$ recursively. Let us imagine that we have constructed the configuration of the lattice to layer $m - 1$, and now we add the layer m . We sum over the configurations of bonds, and that of X-mers and Y-mers on these bonds at the same time.

(i) We note that in the $(m - 1)$ th layer, there are X_m sites that are occupied by X-mers, which protrude to layer m . The first of these sites is connected to a randomly picked site in the lower layer in N ways using an X bond. Then this site in the lower layer is occupied by the extension of that X-mer. The next can be connected to one of the unoccupied sites in the lower layers in only $(N - 1)$ ways. Similarly the third, and so on. The number of ways to do this is

$$\frac{N!}{(N - X_m)!}$$

(ii) Now we take the Y_m Y-mers in the $(m - 1)$ th layer that are extending down to the lower layer. The number of ways of extending these to the $(N - X_m)$ unoccupied sites below is clearly

$$\frac{(N - X_m)!}{(N - X_m - Y_m)!}$$

(iii) Connect the remaining $(N - X_m)$ X bonds between layers $m - 1$ and m to sites in layer m not yet connected by X bonds. The number of ways to do this is

$$(N - X_m)!$$

(iv) Repeat the last procedure with the $N - Y_m$ remaining Y bonds between the layers m and $m + 1$. The number of ways to do this is

$$(N - Y_m)!$$

(v) Finally, the $(N - X_m - Y_m)$ sites in layer m , which are unoccupied so far, are divided into three groups: x_m topmost sites of new X-mers, y_m topmost sites of new Y-mers, and the unoccupied sites. Clearly the number of ways to do this is

$$\frac{(N - X_m - Y_m)!}{x_m! y_m! (N - X_m - Y_m - x_m - y_m)!}$$

The product of these factors gives the total number of ways of adding the m th layer as

$$\frac{N!(N - X_m)!(N - Y_m)!}{x_m! y_m! (N - X_m - Y_m - x_m - y_m)!}. \quad (14)$$

Finally, multiplying these factors for different m , we find the total number of configurations $C(\{x_m, y_m\})$, with specified $\{x_m, y_m\}$, is given by

$$C(\{x_m, y_m\}) = \prod_{m=1}^M \frac{N!(N - X_m)!(N - Y_m)!}{x_m! y_m! (N - X_m - Y_m - x_m - y_m)!}. \quad (15)$$

Putting in the corresponding activity factors, the grand partition function for the whole lattice with M layers is

$$Z_{av} = \frac{1}{(N!)^{2M-2}} \sum_{\{x_m, y_m\}} C(\{x_m, y_m\}) z_1^{\sum x_m} z_2^{\sum y_m}, \quad (16)$$

where the sum is over all possible values of $\{x_m, y_m\}$, and we have divided the multiplicity factor by the number of configurations of the random lattice $(N!)^{2M-2}$ to get the average partition function. Note that $Z_{av} = 1$ for $z_1 = z_2 = 0$, as expected.

The summation over $\{x_m, y_m\}$ yields at most a factor of order N^{2M} . Since the summand is of order $\exp(NM)$, for large N , we can ignore the summation over $\{x_m, y_m\}$, and replace

the summation with the largest term with negligible error. For the summand to be maximum with respect to x_j , we set

$$\frac{C(\{x_m + \delta_{m,j}, y_m\})z_1}{C(\{x_m, y_m\})} \approx 1. \quad (17)$$

This gives

$$z_1 \prod_{s=0}^{k-1} \frac{(N - X_{j+s} - x_{j+s} - Y_{j+s} - y_{j+s})}{(N - X_{j+s})} = \frac{x_j + 1}{(N - X_j)}, \quad (18)$$

and similarly

$$z_2 \prod_{s=0}^{k-1} \frac{(N - X_{j+s} - x_{j+s} - Y_{j+s} - y_{j+s})}{(N - Y_{j+s})} = \frac{(y_j + 1)}{(N - Y_j)}. \quad (19)$$

Writing the maximizing values as $f_j^* = x_j/N$ and $g_j^* = y_j/N$, the equations satisfied by f_j^* and g_j^* in the limit N tends to infinity are

$$z_1 \prod_{s=0}^{k-1} \frac{1 - \rho_x(j+s) - \rho_y(j+s)}{1 - \rho_x(j+s) + f_{j+s}^*} = \frac{f_j^*}{1 - \rho_x(j) + f_j^*}, \quad (20)$$

$$z_2 \prod_{s=0}^{k-1} \frac{1 - \rho_x(j+s) - \rho_y(j+s)}{1 - \rho_y(j+s) + g_{j+s}^*} = \frac{g_j^*}{1 - \rho_y(j) + g_j^*}, \quad (21)$$

where $\rho_x(m)$ and $\rho_y(m)$ are the fractions of sites in layer m covered by X-mers and Y-mers, respectively. Clearly,

$$\rho_x(j) = \sum_{s=0}^{k-1} f_{j-s}^*, \quad \rho_y(j) = \sum_{s=0}^{k-1} g_{j-s}^*. \quad (22)$$

These equations connect f_j^* and g_j^* to their value of f_{j+s}^* and g_{j+s}^* , with $s = 1$ to $k-1$. These may be considered as recursion equations for f_j^*, g_j^* . These recursions work in the direction of decreasing j .

These equations have a simple interpretation. In the equilibrium state, z_1 is the ratio of the probability that a randomly chosen site will be the head of a X-mer to the probability that an X-mer can be placed with this site as the head. The probability that the chosen site is empty is $[1 - \rho_x(j) - \rho_y(j)]$. Given that a given site is empty in layer $(j-1)$, the conditional probability that the site connected to it in the layer j' by an X bond is also empty is $\frac{1 - \rho_x(j') - \rho_y(j')}{1 - \rho_x(j') + f_{j'}^*}$. Multiplying these probabilities for $(k-1)$ consecutive layers, we get the probability that a given site in layer j can be the head of an X-mer to be

$$\frac{\prod_{s=0}^{k-1} [1 - \rho_x(j+s) - \rho_y(j+s)]}{\prod_{s=1}^{k-1} [1 - \rho_x(j+s) + f_{j+s}^*]}.$$

The probability that the chosen site in the j th layer is the head of an X-mer is f_j^* . The ratio of these is $1/z_1$, which gives Eq. (18).

The simplest solution of this is a fixed point solution with $f_j^* = f^*$ and $g_j^* = g^*$, independent of j (away from the boundaries). Then f^* and g^* satisfy the equations

$$z_1(1 - kf^* - kg^*)^k = f^*[1 - (k-1)f^*]^{k-1}, \quad (23a)$$

$$z_2(1 - kf^* - kg^*)^k = g^*[1 - (k-1)g^*]^{k-1}. \quad (23b)$$

These equations are the same as Eq. (10), obtained by assuming the existence of an attractive fixed point of the recursion Eqs. (3). This is not so obvious, specially in the limit $z \rightarrow \infty$. However, for the RLTL lattice, the limit of fully packed lattice is well defined, and causes no difficulties.

From Eq. (15), the entropy per site (divided by k_B) is easily seen to be

$$s(\rho_x, \rho_y) = \left(1 - \frac{k-1}{k}\rho_x\right) \ln\left(1 - \frac{k-1}{k}\rho_x\right) + \left(1 - \frac{k-1}{k}\rho_y\right) \ln\left(1 - \frac{k-1}{k}\rho_y\right) - (1-\rho) \ln(1-\rho) - \frac{\rho_x}{k} \ln \frac{\rho_x}{k} - \frac{\rho_y}{k} \ln \frac{\rho_y}{k}, \quad (24)$$

where $\rho = \rho_x + \rho_y$ is the total density. The same expression for entropy was obtained by DiMarzio [19,26] who used an approximate counting technique for counting configurations on cubic lattices in any dimension. Also, Eq. (24) coincides with the expression for entropy that one obtains by using Gujrati's prescription for calculating free energies on the Bethe lattice [32].

It is easy to see that this expression for the entropy is not everywhere convex. When the value of $s(\rho_x, \rho_y)$, calculated as above, turns out to be in the nonconvex region, it is easily seen that a much larger contribution to the partition function comes from $\{x_m, y_m\}$ that are not nearly uniform, and in a canonical ensemble at fixed ρ_x and ρ_y , the lattice will show phase separation, with one region having higher density than the other. The net effect of this is to replace nonconvex parts of the entropy function by a convex envelope construction. Thus we write the true entropy $\tilde{s}(\rho_x, \rho_y)$ as

$$\tilde{s}(\rho_x, \rho_y) = \mathcal{CE}[s(\rho_x, \rho_y)], \quad (25)$$

where \mathcal{CE} denotes convex envelope.

V. ISOTROPIC-NEMATIC TRANSITION

In this section, we analyze the isotropic-nematic transition when the coordination number is four. From Eq. (24), the expression for entropy, it is straightforward to determine the ordering that has maximum entropy.

Consider the system at a fixed density $\rho = \rho_x + \rho_y$. We define the order parameter ψ by

$$\psi = \frac{\rho_x - \rho_y}{\rho}. \quad (26)$$

Then, it is easy to study the variation of $s(\rho_x, \rho_y)$ as a function of ψ , for fixed ρ . We find that for small ρ , the entropy has a single maximum at $\psi = 0$, but for large enough $\rho > \rho_c$, it develops two symmetrically placed maxima (see Fig. 5). For

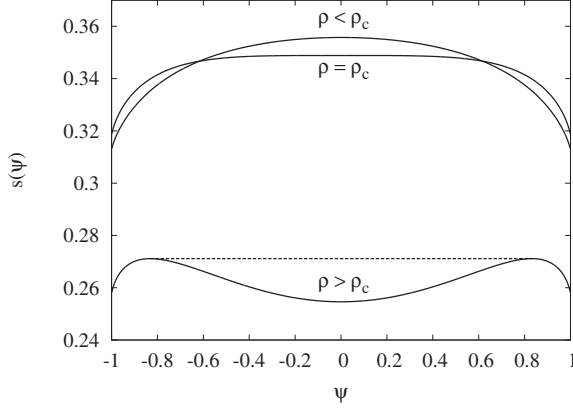

FIG. 5. Entropy as a function of the order parameter ψ for different densities. The data are for $q = 4$ and $k = 4$ when the transition is continuous. Entropy has one peak for small densities and two symmetric peaks for large densities. The dotted lines denote the convex envelope.

small ψ , we can expand the entropy in a power series around $\psi = 0$ as in the standard Landau treatment

$$s(\rho_x, \rho_y) = A(\rho) - \psi^2 B(\rho) - \psi^4 C(\rho) + \dots, \quad (27)$$

where the coefficient $C(\rho) > 0$.

The coefficient of the quadratic term $B(\rho)$ changes sign at $\rho = \rho_c$, and is negative for larger ρ . Thus for $\rho > \rho_c$, we have a nematic phase with nonzero value of ψ . The critical exponent for β for the order parameter takes the classical Landau theory value $1/2$.

The value of ρ_c can be determined easily from Eq. (23). For $z_1 = z_2 = z$, we note that both f^* and g^* are solutions to an equation of the form

$$x \left(1 - \frac{k-1}{k} x \right)^{k-1} = \text{constant}. \quad (28)$$

The left-hand side of the equation is a function of x that starts at zero for $x = 0$, increases to a maximum value, then decreases monotonically, and reaches a positive finite value $(1/k)^{k-1}$, for $x = 1$. When the right-hand constant is small enough, there is only one real-valued solution of this equation, and $f^* = g^*$. For a range of values of the constant, there are exactly two distinct solutions. At the critical point, the two solutions are degenerate. This occurs where the function is maximum, i.e., at

$$x^* = \frac{1}{k-1}. \quad (29)$$

Then at this point $f^* = g^* = x^*/k$ and $\rho_x = \rho_y = 1/(k-1)$. Correspondingly, we have $\rho_c = 2/(k-1)$. The corresponding value of critical activity, from Eq. (23), is

$$z_c = \frac{(k-1)^{2k-2}}{[k(k-3)]^k}, \quad q = 4. \quad (30)$$

We note that the value of z_c is finite only for $k \geq 4$. In Fig. 6, we show the variation of the modulus of the order parameter $|\psi|$ with density ρ for different rod lengths k . The parameter $|\psi|$ is nonzero for densities larger than the critical density.

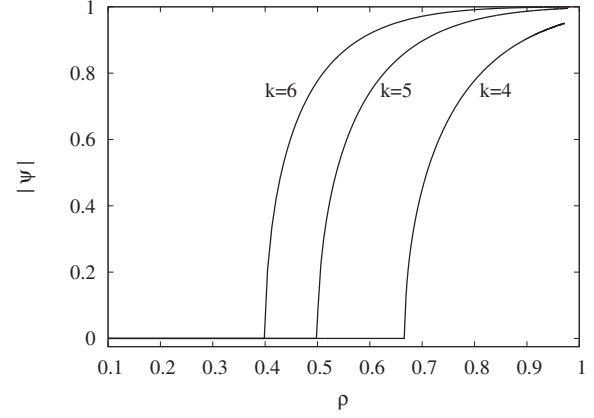

FIG. 6. The modulus of nematic order parameter ψ as a function of the density ρ for different rod lengths k . The data are for $q = 4$.

VI. LATTICES WITH COORDINATION NUMBER $q \geq 6$

The analysis of $q \geq 6$ is very similar. It is easy to check that for general even q , the fixed point solution, which is independent of the layer index j , satisfies the self-consistent equations

$$kz(1-\rho)^k = \rho_i \left[1 - \frac{k-1}{k} \rho_i \right]^{k-1}, \quad i = 1, \dots, \frac{q}{2}, \quad (31)$$

where i labels the $q/2$ different bond types and $\rho = \sum_i \rho_i$ is the total density of sites that are part of k -mers. The entropy per site generalizes to

$$s = \sum_{i=1}^{q/2} \left(1 - \frac{k-1}{k} \rho_i \right) \ln \left(1 - \frac{k-1}{k} \rho_i \right) - (1-\rho) \ln(1-\rho) - \sum_{i=1}^{q/2} \frac{\rho_i}{k} \ln \frac{\rho_i}{k}. \quad (32)$$

The low density phase is isotropic, with ρ_i same for different i . We define the order parameter to be $\psi = (\rho_1 - \rho_2)/\rho$, with $\rho_2 = \dots = \rho_{q/2}$. But now the entropy function has no symmetry under $\psi \rightarrow -\psi$. Then, the expansion of $s(\rho_i)$ in powers of ψ contains cubic terms. Figure 7 shows the behavior of entropy as a function of ψ for different densities ρ when $q = 6$. For small ρ , there is a single maximum at ψ equal to zero. For larger ρ , a second local maximum at a nonzero ψ appears, and at some value of ρ , this becomes of equal height. Then the order parameter jumps discontinuously, as the density is increased.

In Fig. 8, we show the variation of the order parameter ψ with density ρ for $q = 6$ and different values of k , and for $k = 5$ and different values of q . The first-order transition is clearly seen, with the critical activity increasing with q and decreasing with k .

For coordination number greater than four, it is not possible to determine the critical density analytically. The critical densities obtained by numerically comparing the entropy of the isotropic and nematic phases are summarized in Fig. 9. For a fixed value of q , $\rho_c \sim \ln(q)/k$ for large k .

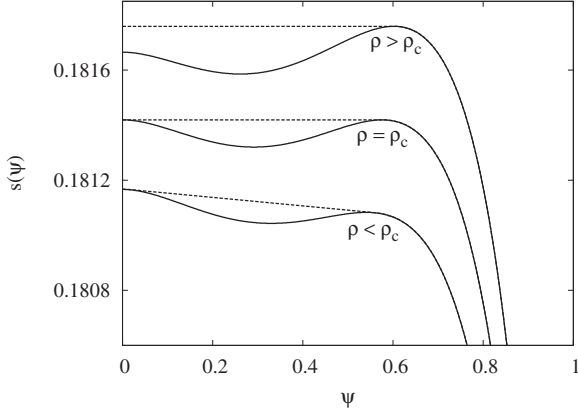

FIG. 7. Entropy as a function of the order parameter ψ for different densities. The data are for $q = 6$ and $k = 8$, when the isotropic-nematic transition is first order. The different curves correspond to (a) $\rho = 0.3890$, (b) $\rho = 0.3910 \approx \rho_c$, and (c) $\rho = 0.3930$. The dotted line shows the convex envelope.

As expected in discontinuous transitions, in a range of values for the densities around the critical density ρ_c , entropy has a local maximum for both the isotropic ($\psi = 0$) and nematic phases. In Fig. 10, the values of densities at which these local maxima appear and disappear, along with the critical density, are shown for $k = 5$ and $k = 8$ for different values of q . Only for $q = 4$, where the transitions are continuous, all the densities coincide.

It is possible to determine the spinodal density ρ_s , the density at which the entropy $s(\psi)$ no longer has a maximum at $\psi = 0$. As in the analysis of $q = 4$, the spinodal is still given by the condition $x^* = 1/(k - 1)$. But now that there are $q/2$ distinct directions, the density at the spinodal point is $q/[2(k - 1)]$. If $q < 2(k - 1)$, the spinodal density is less than one, and entropy will have a maximum at the nematic fixed point. Thus there is always a phase transition for $q < 2(k - 1)$.

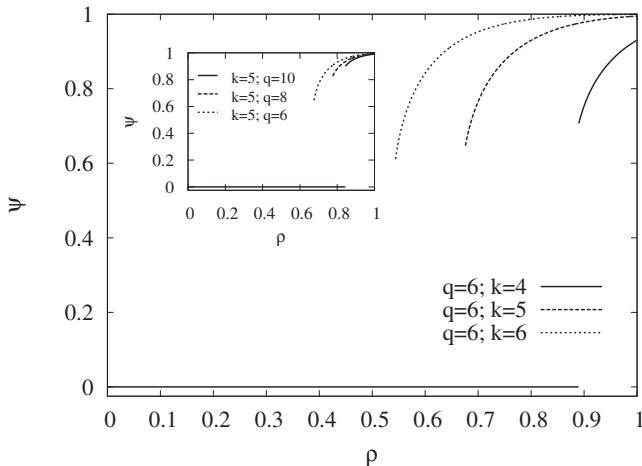

FIG. 8. The order parameter as a function of density ρ for $q = 6$ and varying k . There is a first-order transition at a critical value ρ_c , which decreases with k . Inset: the order parameter ψ as a function of ρ for $k = 5$ and varying q . The value of ρ_c increases with q .

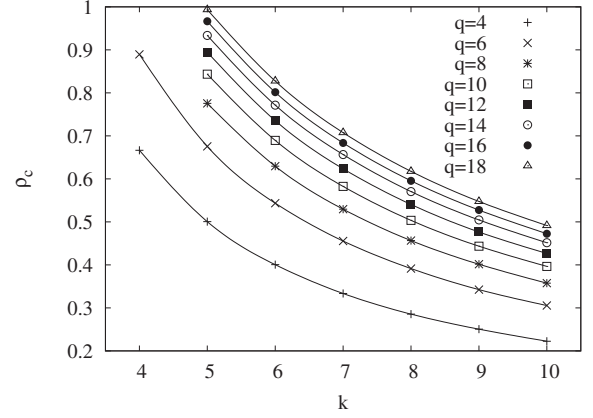

FIG. 9. The critical density ρ_c of the isotropic-nematic phase transition as a function of k for different values of the coordination number q . For $q = 4$ the transition is continuous.

We now address the question of whether for coordination number q , there is a minimum rod length k_{\min} below which the isotropic-nematic transition is absent. From the analysis of the spinodal,

$$k_{\min} \leq \frac{q + 4}{2}. \quad (33)$$

The precise value of k_{\min} is computed numerically and the results are shown in Table I. We find that $k_{\min} \sim \ln(q)$, for $q \gg 1$.

The order parameter at full coverage ψ_{\max} is easy to determine for $k = 4$, when

$$\psi_{\max} = \begin{cases} \frac{5\sqrt{3}}{9} \approx 0.96225, & k = 4, q = 4, \\ \frac{3(\sqrt{6}-4)}{5} \approx 0.93031, & k = 4, q = 6, \\ \frac{13}{15} \approx 0.86667, & k = 4, q = 8. \end{cases} \quad (34)$$

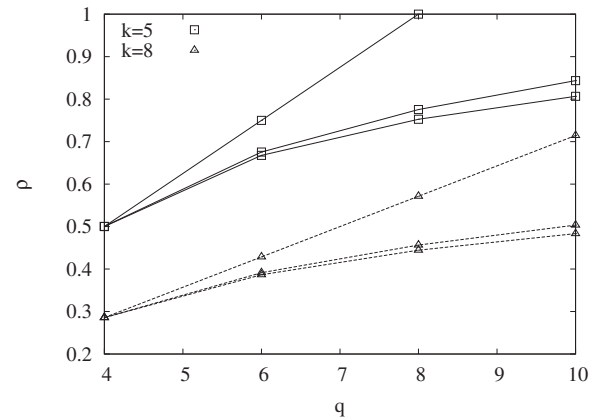

FIG. 10. Coexistence and limits of stability values of density of the isotropic and nematic phases as functions of q for two different rod lengths. For given values of q and k , the lowest point is the density at which $s(\psi)$ develops a second local maximum, the intermediate point is the critical density ρ_c , and the highest point is the density at which $s(\psi)$ is no longer a local maximum at $\psi = 0$. The lines are guides to the eye.

TABLE I. The minimum rod length k_{\min} required for an isotropic-nematic transition as a function of coordination number q .

q	k_{\min}	q	k_{\min}
$q \in [4, 6]$	4	$q \in [656, 1612]$	10
$q \in [8, 18]$	5	$q \in [1614, 3994]$	11
$q \in [20, 44]$	6	$q \in [3996, 9968]$	12
$q \in [46, 110]$	7	$q \in [9970, 25028]$	13
$q \in [112, 266]$	8	$q \in [25030, 63188]$	14
$q \in [268, 654]$	9		

The value of ψ_{\max} grows monotonically with k , being equal to 1 in the limit $k \rightarrow \infty$. It is easy to see that it has the asymptotic behavior

$$1 - \psi_{\max} \approx \frac{q}{2k^{k-1}}, \quad k \rightarrow \infty. \quad (35)$$

We can also look for a periodic solution of period k , where $x_{m+k} = x_m$ and $y_{m+k} = y_m$. In this case, the $2k$ independent parameters f_s^* and g_s^* , with $s = 0$ to $k-1$, satisfy the equations

$$\begin{aligned} f_j^*(1 - \rho_1 + f_j^*) &= z_1(1 - \rho_1 - \rho_2)^k / A, \\ g_j^*(1 - \rho_2 + g_j^*) &= z_2(1 - \rho_1 - \rho_2)^k / B, \end{aligned} \quad (36)$$

where

$$\rho_1 = \sum_{s=0}^{k-1} f_s^* \quad \text{and} \quad \rho_2 = \sum_{s=0}^{k-1} g_s^*, \quad (37)$$

and

$$A = \prod_{s=0}^{k-1} [1 - \rho_1 + f_s^*] \quad \text{and} \quad B = \prod_{s=0}^{k-1} [1 - \rho_2 + g_s^*]. \quad (38)$$

In Eq. (37), the left-hand side is a function of the form $(x + cx^2)$, with c positive, and the right-hand side is independent of j . Hence, the only positive real solution of this equation is of the form f_j^* independent of j , and we do not get a nontrivial periodic solution. Note that a periodic solution would correspond to smectic-like layered ordering, and our solution rules it out.

VII. DISCUSSION

In this paper, we studied the problem of long rods interacting via excluded volume interaction on a Bethe-like lattice. We showed that due to the presence of the local symmetry of interchange of edge labels in a branch a uniform nematic order is not possible on the Bethe lattice. This makes the Bethe approximation not exact on this lattice. We, therefore,

constructed the random locally treelike layered lattice, and showed that the Bethe's self-consistency equations for the correlation functions are exact on this lattice and used them to determine the properties of the hard-rod system. It also turns out that the self-consistent equations for the mean densities are the same for both the RLTL and the Bethe lattice. However, if one was to study correlation functions, then they would differ on the RLTL and Bethe lattices. We also note that the difficulty with the Bethe lattice arises only for problems where the interaction is orientation dependent. For $q = 4$ we find a continuous transition on the RLTL lattice, whereas for larger values of q , one gets a first-order phase transition. This is in qualitative agreement with simulation findings on the two-dimensional square lattice (Ising universality class) and two-dimensional triangular lattices ($q = 3$ Potts universality class).

We are not able to address the nature of the second transition in this study, as on the RLTL lattice, there is none. However, on this lattice, the limit of fully packed lattice is quite interesting. We find that in this limit, the system has long-range nematic order, but the ordering is not complete, and there are small islands of "wrongly" oriented k -mers in a sea of aligned k -mers. The small concentration of these wrongly oriented rods is entropically stabilized.

In recent years, there has been a lot of interest in the study of statistical physics models on different types of random graphs. The fact that one can write exact self-consistent equations on the RLTL lattice, makes it interesting testing ground for such studies. We can easily extend our treatment to semiflexible rods, where all the rods are aligned in the direction of increasing layer number, but a k -mer lying on an X bond between layers j and $(j+1)$ can bend and lie on a Y bond between layers $(j+1)$ and $(j+2)$ with some energy cost. Earlier studies of flexible and semiflexible polymers on Bethe and Husimi lattices can be found in Refs. [39,40].

There are other models, like the axial next-nearest-neighbor Ising model (ANNNI model) [41], where exact solution in dimensions greater than one is not possible, and the equilibrium state shows spatial structure. These are usually discussed in the spatially varying mean-field approximation. The RLTL lattice may be useful in the study of such models as it can take into account the short-range correlations in these systems better.

ACKNOWLEDGMENTS

The work of D.D. and R.R. was partially supported by the Department of Science and Technology, Government of India under the project DST/INT/Brazil/RPO-40/2007, and that of JFS by CNPq under the project No. 490843/2007-7. We thank Ronald Dickman for a careful reading of the manuscript.

- [1] N. Clisby and B. M. McCoy, *Pramana* **64**, 775 (2005).
 [2] P. A. Pearce and K. A. Seaton, *J. Stat. Phys.* **53**, 1061 (1988).
 [3] H. C. M. Fernandes, J. J. Arenzon, and Y. Levin, *J. Chem. Phys.* **126**, 114508 (2007).

- [4] R. J. Baxter, *J. Phys. A: Math. Gen.* **13**, L61 (1980).
 [5] A. Verberkmoes and B. Nienhuis, *Phys. Rev. Lett.* **83**, 3986 (1999).
 [6] B. C. Barnes, D. W. Siderius, and L. D. Gelb, *Langmuir* **25**, 6702 (2009).

- [7] Y. Maeda, T. Niori, J. Yamamoto, and H. Yokoyoma, *Thermochim. Acta* **431**, 87 (2005).
- [8] G. J. Vroege and H. N. W. Lekkerkerker, *Rep. Prog. Phys.* **55**, 1241 (1992).
- [9] L. Onsager, *Ann. N.Y. Acad. Sci.* **51**, 627 (1949).
- [10] P. J. Flory, *Proc. R. Soc.* **234**, 60 (1956).
- [11] R. Zwanzig, *J. Chem. Phys.* **39**, 1714 (1963).
- [12] K. Shundyak and R. van Roij, *Phys. Rev. E* **69**, 041703 (2004).
- [13] D. Dhar and S. Chandra, *Phys. Rev. Lett.* **100**, 120602 (2008).
- [14] O. J. Heilmann and E. Lieb, *Commun. Math. Phys.* **25**, 190 (1972).
- [15] D. A. Huse, W. Krauth, R. Moessner, and S. L. Sondhi, *Phys. Rev. Lett.* **91**, 167004 (2003).
- [16] P. G. de Gennes and J. Prost, in *The Physics of Liquid Crystals* (Oxford University Press, Oxford, 1995), pp. 64–66.
- [17] A. Ghosh and D. Dhar, *Europhys. Lett.* **78**, 20003 (2007).
- [18] D. A. Matoz-Fernandez, D. H. Linares, and A. J. Ramirez-Pastor, *Europhys. Lett.* **82**, 50007 (2008).
- [19] D. A. Matoz-Fernandez, D. H. Linares, and A. J. Ramirez-Pastor, *Physica A* **387**, 6513 (2008).
- [20] D. A. Matoz-Fernandez, D. H. Linares, and A. J. Ramirez-Pastor, *J. Chem. Phys.* **128**, 214902 (2008).
- [21] D. H. Linares, F. Romá, and A. J. Ramirez-Pastor, *J. Stat. Mech.* (2008) P03013.
- [22] T. Fischer and R. L. C. Vink, *Europhys. Lett.* **85**, 56003 (2009).
- [23] D. Ioffe, Y. Velenik, and M. Zahradnik, *J. Stat. Phys.* **122**, 761 (2006).
- [24] H. A. Bethe, *Proc. R. Soc. London A* **150**, 552 (1935).
- [25] G. S. Rushbrooke, *Proc. R. Soc. London A* **166**, 296 (1938).
- [26] E. DiMarzio, *J. Chem. Phys.* **35**, 658 (1961).
- [27] M. Kurata, R. Kikuchi, and T. Watari, *J. Chem. Phys.* **21**, 434 (1953).
- [28] G. S. Rushbrooke and H. I. Scoins, *Proc. R. Soc. London A* **230**, 74 (1955).
- [29] L. K. Runnels, *J. Math. Phys.* **8**, 2081 (1967).
- [30] T. P. Eggarter, *Phys. Rev. B* **9**, 2989 (1973).
- [31] E. Müller-Hartmann and J. Zittartz, *Phys. Rev. Lett.* **33**, 893 (1974).
- [32] P. D. Gujrati, *Phys. Rev. Lett.* **74**, 809 (1995).
- [33] R. J. Baxter, *Exactly Solved Models in Statistical Mechanics*, Chap. 4 (Academic Press, London, 1982).
- [34] B. Bollobás, in *Random Graphs* (Cambridge University Press, Cambridge, 2001), p. 56.
- [35] C. Baillie, D. A. Johnston, and J. P. Kownacki, *Nucl. Phys. B* **432**, 551 (1994).
- [36] D. Dhar, P. Shukla, and J. P. Sethna, *J. Phys. A* **30**, 5259 (1997).
- [37] A. Dembo and A. Montanari, *Annals Appl. Prob.* **20**, 565 (2010).
- [38] A. Dembo and A. Montanari, *Brazilian J. Prob. Stat.* **24**, 137 (2010).
- [39] J. F. Stilck and M. J. de Oliveira, *Phys. Rev. A* **42**, 5955 (1990).
- [40] E. Botelho and J. F. Stilck, *Phys. Rev. E* **48**, 723 (1993).
- [41] W. Selke, *Phys. Rep.* **170**, 213 (1988).