

Quasiparticle interactions in fractional quantum Hall systems: Justification of different hierarchy schemes

Arkadiusz Wójs

*Department of Physics, University of Tennessee, Knoxville, Tennessee 37996
and Institute of Physics, Wrocław University of Technology, 50-370 Wrocław, Poland*

John J. Quinn

Department of Physics, University of Tennessee, Knoxville, Tennessee 37996

(Received 23 August 1999)

The pseudopotentials describing the interactions of quasiparticles in fractional quantum Hall (FQH) states are studied. Rules for the identification of incompressible quantum fluid ground states are found, based upon the form of the pseudopotentials. States belonging to the Jain sequence $\nu = n(1 + 2pn)^{-1}$, where n and p are integers, appear to be the only incompressible states in the thermodynamic limit, although other FQH hierarchy states occur for finite size systems. This explains the success of the composite Fermion picture.

I. INTRODUCTION

The fractional quantum Hall (FQH) effect,¹⁻⁴ i.e., quantization of the Hall conductance of a two-dimensional electron gas (2DEG) at certain densities in high magnetic fields, is a consequence of finite excitation gaps that open above (incompressible) nondegenerate ground states (GS's) at certain fractional fillings of the lowest Landau level (LL), $\nu = 1/3, 2/5$, etc. Because of the LL degeneracy, it is clear that those incompressible GS's must originate from electron-electron interactions. This makes the physics of the FQH effect very different from that underlying the integer quantum Hall (IQH) effect,^{5,6} despite similar manifestation of the two in transport experiments.

While the origin of most prominent FQH states at $\nu = 1/m$ (m is an odd integer) has been explained by Laughlin,² our understanding of why such states are also formed at some other filling factors (independent of the sample, density, etc.) or what conditions must in general be satisfied for an interacting system to exhibit the FQH effect at different fractions, is not yet completely satisfactory. As an extension of Laughlin's idea, Haldane⁷ and others⁸⁻¹¹ proposed different, although equivalent,¹²⁻¹⁴ hierarchy schemes, in which the elementary quasiparticlelike excitations of the Laughlin fluid form Laughlin-like states of their own. However, the original hierarchy approaches all share a major problem: they predict too many fractions and give no apparent connection between the stability of a given state and the hierarchy level at which it occurs. It is known^{1,15-18} that the FQH effect does not occur at some simple fractions predicted at low levels of hierarchy, while explanation of some other, experimentally observed ones requires introducing many generations of excitations.

A different approach, introduced by Jain¹⁹ and developed by Lopez and Fradkin²⁰ and by Halperin, Lee, and Read,²¹ involves the concept of composite fermions (CF's). As formally described by the mean-field Chern-Simons (CS) transformation, the CF's are constructed by binding part of the external magnetic field B to electrons in form of infinitely

thin solenoids, each carrying an even number $2p$ of flux quanta. The resulting CF's move in an effective, reduced field B^* . Smaller LL degeneracy of CF's leads to a lower effective filling factor ν^* given by

$$(\nu^*)^{-1} = \nu^{-1} - 2p. \quad (1)$$

It was found that the sequence of fractional electron filling factors ν corresponding to integer CF fillings ν^* agrees with the values at which FQH states occur. The qualitative success of the CF picture led to the conjecture that the CS charge-flux and Coulomb charge-charge interactions beyond the mean field largely cancel one another, and the system of strongly interacting electrons in a high magnetic field is converted to one of weakly interacting CF's in a lower field. However, this cannot possibly be correct, since the CS energy ($\propto B$) and Coulomb energy ($\propto \sqrt{B}$) scale differently with the magnetic field B . Also, higher LL's used in the procedure to obtain the wave functions are later eliminated by projection, which puts in doubt their role in the final result and most likely does not allow for interpretation in terms of an additional, effective magnetic field.

In this paper we attempt to justify Haldane's hierarchy picture in terms of the behavior of the interaction between quasiparticles (QP's), which he considered of importance but totally unknown. We derive simple rules for identifying fractions that do or do not correspond to incompressible FQH states by analyzing pseudopotentials²²⁻²⁵ of the QP interactions on successive levels of hierarchy. Based on the connection between the form of pseudopotential (pair energy versus pair angular momentum) and the nature of low-lying states, we explain why QP's do not form Laughlin states at all $1/m$ fillings. Our results validate understanding of experimentally observed FQH states in intuitive terms of the hierarchy of Laughlin excitations, established in Refs. 7-11. We also show that (in large systems) valid incompressible FQH states obtained in this hierarchy picture are equivalent to Jain states, despite the different underlying physics used to justify the two approaches. This explains the success of the CF picture when applied to FQH systems better than the assumed

cancellation between CS and Coulomb interactions. It also defines limitations of the CF picture when applied to systems with general interactions (e.g., recently studied FQH systems of charged excitonic complexes formed in an electron-hole gas in a high magnetic field^{26–28}). The discussion is illustrated with results of exact numerical diagonalization calculations on a Haldane sphere⁷ carried out for up to twelve electrons at $\nu \approx 1/3$ (Hamiltonians with dimensions of up to 3×10^6) using a modified Lanczos²⁹ algorithm.

II. HALDANE SPHERE

Because in the absence of electron-electron interactions all many-body states in the lowest LL ($\nu \leq 1$) are degenerate, those interactions cannot be treated perturbatively. Therefore, numerical diagonalization techniques are commonly used to study FQH systems, which, however, limit their size to a finite (small) number of electrons. In order to model a finite density 2DEG, motion of N electrons must be restricted to a finite area. This can be accomplished by imposing lateral confinement,³⁰ periodic boundary conditions (PBC),³¹ or confining electrons on a closed surface (Haldane sphere).⁷

The last approach is particularly useful as it naturally avoids edge effects and preserves full two-dimensional (2D) translational symmetry of a planar 2DEG in the form of the rotational symmetry of a sphere. A pair of good quantum numbers on a plane, the center of mass (CM), and relative momenta, correspond to the total angular momentum L and its projection L_z on a sphere.³² The degeneracies associated with CM excitations on a plane correspond to those of L multiplets on a sphere, and the nondegenerate GS's of a planar 2DEG have $L = 0$ in their spherical models.

The magnetic field B perpendicular to the surface of the Haldane sphere of radius R is an isotropic radial field produced by a magnetic monopole placed at the origin. The monopole strength $2S$, defined as the number of flux quanta piercing the sphere, is an integer, as required by Dirac's condition.³³ In the extrapolation of finite-size results to the thermodynamic limit, the magnetic length $\lambda = R/\sqrt{S}$ is used as the length scale. The single-particle states on the Haldane sphere are labeled by angular momentum $l \geq S$ and its projection l_z and are called monopole harmonics.^{7,34,35} The energies form $(2l+1)$ -fold degenerate angular momentum shells, or LL's, labeled by $n = l - S$ and separated by cyclotron gaps. For the FQH states at $\nu < 1$, only the lowest ($n = 0$) spin-polarized angular momentum shell of $l = S$ need be considered. The N -electron Laughlin $\nu = 1/m$ states in a $2l + 1$ degenerate shell occur at $2l = m(N - 1)$.

III. HIERARCHY OF LAUGHLIN EXCITATIONS

Haldane's hierarchy of FQH states is constructed in the following way. At certain filling factors, $\nu = 1/m$ (m is an odd integer), electrons form Laughlin incompressible states. At ν slightly different from a Laughlin $1/m$ filling, the low-lying states must contain a number of quasiparticles (QP's)—quasielectrons (QE's) at $\nu > 1/m$ or quasiholes (QH's) at $\nu < 1/m$ —in the Laughlin $\nu = 1/m$ state. States involving more than the minimum number of QP's required by the difference between ν and $1/m$ contain additional QE-QH pairs³⁶ and are separated from the lowest band by a gap Δ .

The QP's in the underlying (parent) Laughlin state have a certain single-particle energy ε_{QP} , statistics, number of available single-particle states g_{QP} (in analogy to LL degeneracy for electrons) and interact with one another. Provided their interaction is small compared to Δ and ε_{QP} , QP's can, in principle, form Laughlin incompressible (daughter) states of their own. If ν is not exactly equal to the value at which QP's would form a daughter Laughlin state, low-lying QP states will contain their own QP-like excitations in the nearest-daughter Laughlin state, which can in turn form an incompressible granddaughter Laughlin state, etc.

Since the QE or QH statistics enters the hierarchy of fractions only through the counting of many-body states, different statistics give equivalent results as long as the single-particle degeneracies g_{QE} and g_{QH} are chosen correctly. The mean-field CS transformation can be used to formally convert bosons into fermions by attaching one flux quantum to each boson.^{37–39} For example, in the spherical geometry, where $g_{\text{QP}} = 2l_{\text{QP}} + 1$ is related to QP angular momentum l_{QP} , systems of N bosons each with angular momentum k and N fermions each with angular momentum l are equivalent and contain the same L multiplets if

$$l = k + (N - 1)/2. \quad (2)$$

As shown by Haldane⁷ (and can be understood from a simple picture of excitations created between electrons on a line), QE's and QH's in an N -electron Laughlin state can be viewed as bosons with $k_{\text{QE}} = k_{\text{QH}} = N/2$. However, this combination of statistics and degeneracy gives proper counting of many-body states only if an additional hard core is introduced that forbids two QE's to be in a pair state with $L = N$.⁴⁰ Such a hard core can be accounted for by a mean-field fermion-to-fermion CS transformation that replaces k_{QE} by $k_{\text{QE}}^* = k_{\text{QE}} - (N_{\text{QE}} - 1)$,^{23–25} where N_{QP} is the QP number.

In order to stress the connection with Jain's CF picture and the recently proposed¹¹ hierarchy of CF excitations, we use here a fermionic description of QP's. The appropriate QP angular momenta obtained from Eq. (2) are

$$l_{\text{QP}} = \frac{N \pm (n_{\text{QP}} - 1)}{2}, \quad (3)$$

with $-$ for l_{QE} and $+$ for l_{QH} . Note that l_{QE} and l_{QH} given by Eq. (3) are equal to angular momenta of holes in highest filled and particles in lowest empty CF LL's used in the CF picture.

The expression for the filling factor ν of a daughter state is very similar to Eq. (1) and reads¹¹

$$\nu^{-1} = 2p + (1 \pm \nu_{\text{QP}})^{-1}, \quad (4)$$

where ν_{QP} is the filling factor of QE's (+) or QH's (−) in the Laughlin $(2p + 1)^{-1}$ parent state. Iteration of Eq. (4) with ν_{QP} substituted by ν gives a continuous fraction, terminated when an incompressible state (without QP's, $\nu_{\text{QP}} = 0$) is reached. For example, for the state containing $\nu = 1/5$ filling of QH's in the $\nu = 1$ filling of QE's in the Laughlin $\nu = 1/3$ state of electrons, this procedure gives

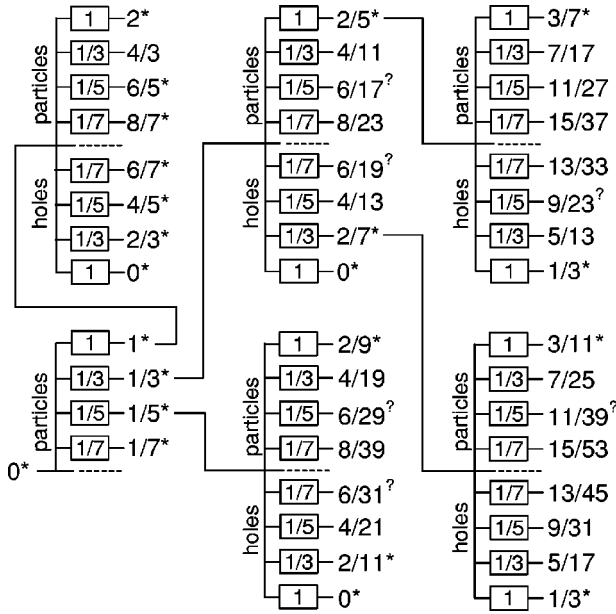

FIG. 1. Diagram of filling factors obtained in the hierarchy of Laughlin excitations. Lines connect parent and daughter states with quasiparticle filling factors shown in boxes. Asterisks, incompressible states; question marks, hierarchy ground states observed only in finite systems; other fractions, compressible states.

$$\nu = \frac{1}{2 \times 1 + \frac{1}{1 + \frac{1}{2 \times 0 + \frac{1}{1 - \frac{1}{2 \times 2 + \frac{1}{1 + 0}}}}} = \frac{9}{23}. \quad (5)$$

In Fig. 1 we display more filling factors obtained in the hierarchy scheme. The lines connect parent states with their daughter states obtained for QP fillings ν_{QP} shown in boxes. Note that holes created in a parent state of holes are particles in the grandparent state (in a sense that their presence increases overall ν , i.e. their number increases when the magnetic field is decreased). For example, holes created in the $\nu=1/3$ filling of holes in the $\nu=1/3$ Laughlin state of electrons will be referred to as QE's in the $\nu=2/7$ state.

As first stated by Haldane,⁷ whether a given fraction obtained in the hierarchy scheme corresponds to a stable incompressible GS depends on the stability of the parent state and on the interaction between QP's in the daughter state. As will be shown in the following sections, these criteria eliminate most of all odd denominator fractions that can be constructed by an iteration of Eq. (4). The relatively small number of possible candidates left include the Jain sequence obtained from Eq. (1) for integer ν^* . These states (and their electron-hole conjugates) have been marked with asterisks in Fig. 1. As will be shown in the following sections, these are all the incompressible states predicted by the "correct" hierarchy picture in the thermodynamic limit, and all of them have been confirmed experimentally.^{1,15-18} The fractions with a question mark in Fig. 1 are most likely compressible in the thermodynamic limit, but valid nondegenerate (L

=0) hierarchy GS's can occur at these fillings in finite systems. Those finite size valid hierarchy GS's (Laughlin states of Laughlin QP's) should be distinguished from other $L=0$ GS's that can occur at different combinations of N and $2S$ [e.g., for $N=12$ and $2S=29$ in Fig. 3(c) of Ref. 11], but do not have Laughlin-like QP correlations and thus cannot be associated with a filling factor. At the remaining filling factors, unmarked in Fig. 1, the hierarchy picture fails as expected and the system is compressible.

IV. PSEUDOPOTENTIALS

The two-body interaction of identical particles in an angular momentum shell of degeneracy $2l+1$ can be written in terms of the pseudopotential²² $V(\mathcal{R})$, i.e. the pair interaction energy V as a function of relative pair angular momentum

$$\mathcal{R} = 2l - L, \quad (6)$$

where L is the total angular momentum of the pair.⁴¹ \mathcal{R} is an odd integer and increases with increasing average separation.²⁵ Plotting V as a function of \mathcal{R} rather than of L allows for meaningful comparison of pseudopotentials in shells of different degeneracy; for $l \rightarrow \infty$, the pseudopotentials calculated on the sphere converge to the pseudopotential on a plane (on a plane, \mathcal{R} is defined³² as the usual relative angular momentum).

Whether a system of interacting fermions will form a Laughlin state at the $1/m$ filling of their angular momentum shell depends on the short range of repulsive interaction. Precisely, the Laughlin $\nu=1/m$ incompressible state (in which $\mathcal{R} \geq m$ for all pairs) is formed if,²⁵ in the vicinity of $\mathcal{R}=m$, the interaction pseudopotential increases more quickly than linearly as a function of $L(L+1)$, i.e., more quickly than that of harmonic repulsion, $V_{\text{H}}(L) = \alpha + \beta L(L+1)$, where α and β are constants. More generally, if this condition is satisfied in the vicinity of $\mathcal{R}=2p+1$ for certain p , the total many-body Hilbert space \mathcal{H} contains an (approximate) eigensubspace²⁵ \mathcal{H}_p holding states with $\mathcal{R} \geq 2p+1$ for all pairs (i.e., avoiding p pair states of largest repulsion). A corresponding low-energy band occurs in the spectrum, separated from higher states by a gap associated with $V(\mathcal{R})$. At Laughlin fillings of $\nu=(2p+1)^{-1}$, the subspace \mathcal{H}_p contains a single nondegenerate ($L=0$) multiplet with $\mathcal{R} \geq 2p+1$, and the lowest band consists of the Laughlin GS.

The mathematical formalism derived to quantitatively treat the ability of electrons to avoid certain pair states involves the concept of fractional (grand) parentage,^{42,43} well known in atomic and nuclear physics and used recently²³⁻²⁵ to describe FQH systems. It is worth noting that avoiding highest-energy states of three or more particles was recently proposed⁴⁴ to explain incompressible GS's at other fillings than Laughlin's $\nu=1/m$.

The electron (Coulomb) pseudopotential in the lowest LL $V_e(\mathcal{R})$ satisfies²³⁻²⁵ the "short-range" criterion (i.e., increases more quickly than V_{H} as a function of L) in entire range of \mathcal{R} , which is the reason for incompressibility of principal Laughlin $\nu=1/m$ states. However, this does not generally hold for the QP pseudopotentials^{45,46} on higher levels of hierarchy. We have obtained some of those pseudopotentials for different values of l_{QP} by numerical diagonaliza-

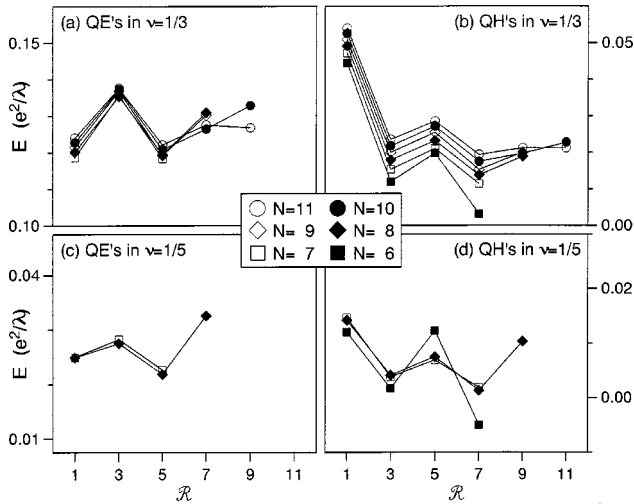

FIG. 2. Energies $E = 2\varepsilon + V(\mathcal{R})$ of a pair of quasielectrons (left) and quasiholes (right) in Laughlin $\nu = 1/3$ (top) and $\nu = 1/5$ (bottom) states, as a function of relative pair angular momentum \mathcal{R} , obtained in diagonalization of N electrons.

tion of appropriate many-electron Hamiltonians on the Haldane sphere and identification of the lowest bands in obtained energy spectra. The total many-electron energies within those bands contain the energy E_0 of the parent state, single-particle energies $2\varepsilon_{QP}$ of the pair of appropriate QP's, and the QP-QP interaction energy $V_{QP}(L)$. In Fig. 2 we show the results for QE's and QH's in Laughlin $\nu = 1/3$ (data for $N \leq 8$ was published before in Ref. 46) and $\nu = 1/5$ states. The plotted energy $E(\mathcal{R}) = 2\varepsilon_{QP} + V_{QP}(L)$ is given in units of e^2/λ , where λ is the magnetic length in the parent state. Different symbols mark pseudopotentials obtained in diagonalization of N -electron systems with different N and thus with different l_{QP} ; see Eq. (3). Clearly, the QE and QH pseudopotentials are quite different and neither one decreases monotonically with increasing \mathcal{R} . On the other hand, the corresponding pseudopotentials in $\nu = 1/3$ and $1/5$ states look similar, only the energy scale is different. The convergence of energies at small \mathcal{R} obtained for larger N suggests that the maxima at $\mathcal{R} = 3$ for QE's and at $\mathcal{R} = 1$ and 5 for QH's, as well as the minima at $\mathcal{R} = 1$ and 5 for QE's and at $\mathcal{R} = 3$ and 7 for QH's, persist in the limit of large N (i.e., for an infinite system on a plane). Consequently, the only incompressible daughter states of Laughlin $\nu = 1/3$ and $1/5$ states are those with $\nu_{QE} = 1$ or $\nu_{QH} = 1/3$ (asterisks in Fig. 1) and (maybe) $\nu_{QE} = 1/5$ and $\nu_{QH} = 1/7$ (question marks in Fig. 1). It is also clear that no incompressible daughter states will form at, e.g., $\nu = 4/11$ or $4/13$.

Let us note that the incompressibility of daughter states with completely filled QE shell (e.g., at $\nu = 2/5$ or $2/9$) does not require any special form of the QE-QE interaction, except that it must be weaker than the single-particle energies ε_{QE} and ε_{QH} responsible for the gap. In this sense, the FQH effect at Jain filling $\nu = 2/5$ can be viewed as an IQH effect of QE's in the Laughlin $\nu = 1/3$ state, except that the degenerate single-particle shell available to QE's is due to a special form of elementary excitations of the parent Laughlin state rather than due to an effective magnetic field. Similarly, the excitation gap at the $\nu = 2/5$ filling is not a cyclotron gap but the energy needed to create a QE-QH pairlike excitation in

the filled shell of Laughlin QE's. On the other hand, the FQH effect at $\nu = 2/7$ is a fractional effect also on the level of QH's in the parent $\nu = 1/3$ state, and its excitation gap is governed by $V_{QH}(1)$, the largest pseudopotential parameter for the QH-QH interaction.

The electron pseudopotential $V_e(\mathcal{R})$ is not strictly a short-range one [for which $V(1) \gg V(3) \gg \dots$] and the associated hidden symmetry responsible for occurrence of eigensubspaces \mathcal{H}_p and incompressible Laughlin states is only approximate. Actually, a fairly small reduction of $V_e(1)$ compared to $V_e(3)$ that can be achieved in a wide quantum well leads to a breakdown of the Laughlin $\nu = 1/3$ state.⁴⁷ While the hidden symmetry makes the low-lying states near Laughlin fillings virtually insensitive to the details of $V_e(\mathcal{R})$ as long as it has short range (i.e. increases more quickly than V_H as a function of L), it is interesting to ask to what extent the form of $V_e(\mathcal{R})$ affects the QP pseudopotentials, and thus the incompressibility of related daughter states. We have compared the pseudopotentials in Fig. 2 with the ones obtained for "exponential" interaction, $V_{\text{exp}}(\mathcal{R}+2) = V_{\text{exp}}(\mathcal{R})/10$, and for "selective" interaction, $V_{\text{sel}}(\mathcal{R} < m) = \infty$, $V_{\text{sel}}(m) = 1$, and $V_{\text{sel}}(\mathcal{R} > m) = 0$, and found that all the features in Fig. 2 remain unchanged. This means that the short-range character of interaction between particles in the parent state does not imply the same for interaction between Laughlin QP's in the daughter state. This observation, essential for understanding why incompressible states do not occur at all odd denominator fractions, might appear somewhat surprising since the QP's are (fractionally) charged objects and hence their interaction has a similar nature to that of electrons. However, it must be kept in mind that it is the combination of interaction potential $V(r)$ and available single particle Hilbert space that gives pseudopotential $V(\mathcal{R})$ and, in turn, determines if Laughlin states occur [e.g., for the same Coulomb potential $V(r) = e^2/r$, the Laughlin $\nu = 1/3$ state occurs in the lowest LL but does not occur in the excited ones^{25,48}].

Once the Laughlin-like states on a given hierarchy level are found, the QP pseudopotentials must be calculated for these states to determine if they in turn can have any incompressible daughter states. As an example of this procedure, in Fig. 3 we present a few pseudopotentials calculated for the $\nu = 2/5$, $2/7$, and $2/9$ parent states. As in Fig. 2, the energy $E(\mathcal{R}) = 2\varepsilon_{QP} + V_{QP}(L)$ is given in units of e^2/λ , with λ appropriate for the parent state, and N is the number of electrons in the system that was diagonalized to obtain a particular pseudopotential.

The pseudopotentials plotted in Fig. 3 show two types of behavior at small \mathcal{R} . The ones in Figs. 3(b,c,f) have a maximum at $\mathcal{R} = 3$, similarly as those in Figs. 2(a,c), while the ones in Figs. 3(a,d,e) increase when \mathcal{R} increases between 1 and 5. Similar behavior of different pseudopotentials is a consequence of the particle-hole symmetry between QE's of a parent state and QH's of its daughter state with filled QE shell ($\nu_{QE} = 1$; see Fig. 1). For example, vacancies in an almost completely filled shell of QE's in the $\nu = 1/3$ state are QH's of the $\nu = 2/5$ state; vacancies in an almost completely filled shell of QE's in the $\nu = 2/5$ state are QH's of the $\nu = 3/7$ state, etc. The relation between QH's in the parent state and QE's in the daughter state with $\nu_{QH} = 1$ is equivalent, as the latter is simply the grandparent state. The

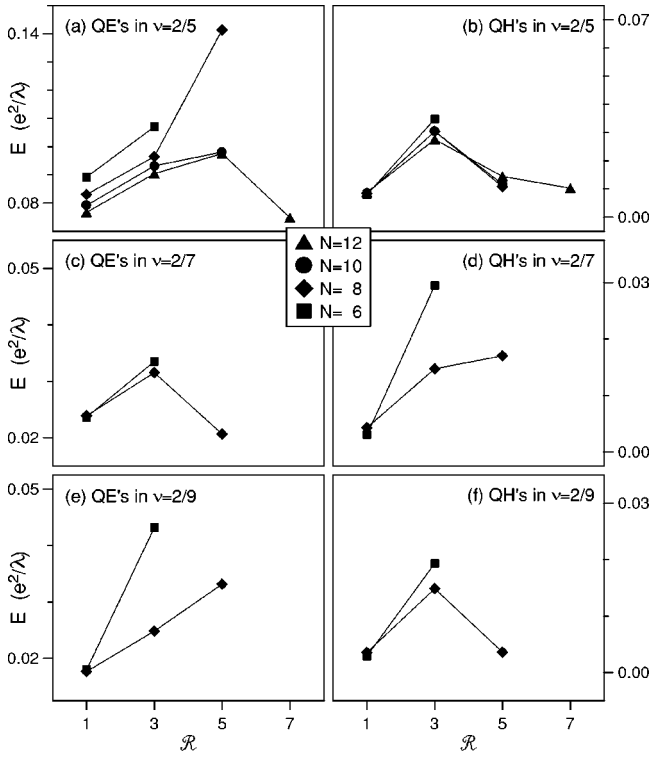

FIG. 3. Energies $E = 2\varepsilon + V(\mathcal{R})$ of a pair of quasielectrons (left) and quasiholes (right) in the second-level hierarchy states at $\nu = 2/5$ (top), $\nu = 2/7$ (center), and $\nu = 2/9$ (bottom), as a function of relative pair angular momentum \mathcal{R} , obtained in diagonalization of N electron systems.

particle-hole symmetry discussed above is only approximate because the single particle gaps are not infinitely large compared to single particle gaps Δ and ε , and the QP number is not strictly conserved. However, the appropriate pseudopotentials are to a good approximation equal, and, e.g., by comparing our data for QE's in $\nu = 1/3$ and QH's in $\nu = 2/5$ we were able to extract energies ε_{QH} of a single QH in the $\nu = 2/5$ state as a function of the system size N . The linear extrapolation to $1/N \rightarrow 0$ gives $\varepsilon_{\text{QH}} = 0.0098e^2/\lambda$, and the limiting value of the ‘‘proper’’ QH energy^{35,49} (including additional fractional charge $e/5$ in the background) is $\tilde{\varepsilon}_{\text{QH}} = 0.0123e^2/\lambda$.

It is apparent from Fig. 3 that the incompressible daughter states derived from $\nu = 2/5$, $2/7$, or $2/9$ must either have a completely filled QE shell (Jain fractions $\nu = 3/7$, $3/11$, and $3/13$, respectively), or (possibly) the $1/5$ filling of QH's ($\nu = 9/23$, $9/31$, and $9/41$, respectively). Incompressible daughter states at any other fractions, including the $1/3$ filling of QE's or QH's (giving such fractions as $\nu = 5/13$ or $7/17$; see Fig. 1) do not occur.

V. NUMERICAL TESTS FOR FINITE SYSTEMS

In order to test the predictions of low-lying states in terms of Laughlin QP's interacting through appropriate pseudopotentials, we have calculated numerically exact energy spectra of up to twelve electrons on the Haldane sphere at different values of the monopole strength $2S$, i.e., different filling factors. As demonstrated on the examples presented in Fig. 4, the results (in all cases we looked at) can be very well

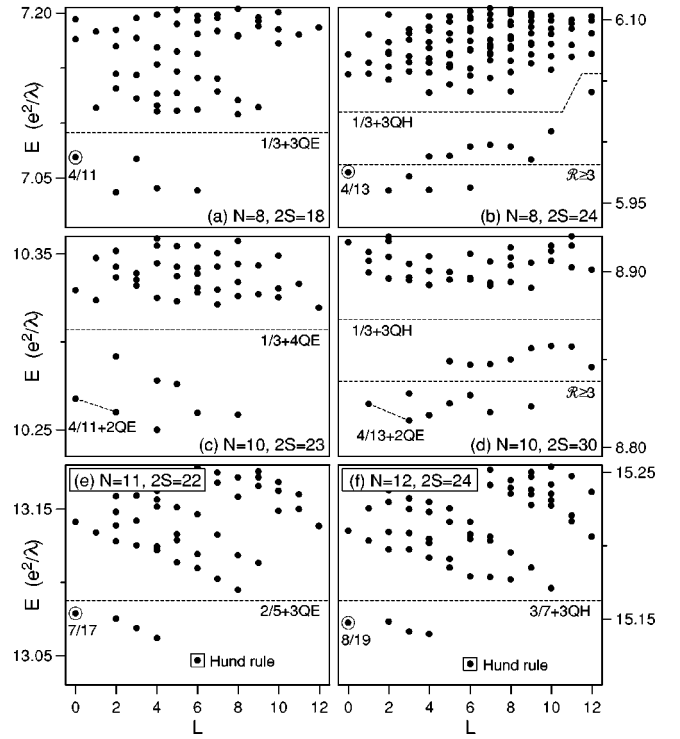

FIG. 4. Few electron energies E as a function of total angular momentum L , obtained in exact diagonalization in terms of individual electrons interacting through the Coulomb pseudopotential. Dashed lines mark gaps separating energy bands.

understood in terms of the QP-QP interaction. Figure 4(a) shows the spectrum of eight electrons at $2S = 18$. The low-lying band contains states of three QE's in Laughlin $\nu = 1/3$ state, each with $l_{\text{QE}} = 3$ ($L = 0, 2, 3, 4$, and 6). As marked with a dashed line, there is a gap separating the low-energy band from higher states. Due to the QE-QE interaction, the lowest band is not degenerate and has a certain width. Because this width is small compared to the gap to higher states (i.e., to energy Δ to create additional QE-QH pairs), the three QE's interact with one another in the presence of a rigid background (Laughlin fluid at $\nu = 1/3$), and the low-lying states are determined by the pseudopotential $V_{\text{QE}}(\mathcal{R})$ obtained for the same $l_{\text{QE}} = 3$ [$N = 7$ in Fig. 2(a)]. If $V_{\text{QE}}(\mathcal{R})$ had short range, the multiplet at $L = 0$ would be an incompressible GS corresponding to the Laughlin $\nu_{\text{QE}} = 1/3$ state and total electron filling factor of $\nu = 4/11$. However, as discussed in the previous section, $V_{\text{QE}}(\mathcal{R})$ has a minimum at $\mathcal{R} = 1$ and the system is compressible (in this small system, the Laughlin $\nu_{\text{QE}} = 1/3$ state is an eigenstate as it is the only state of three QE's in the $L = 0$ subspace; in larger systems, it will mix with other $L = 0$ states and fall into the continuum).

A similar spectrum is displayed in Fig. 4(b). Here, the low-lying states contain three QH's in the Laughlin $\nu = 1/3$ state, each with $l_{\text{QH}} = 5$. As expected from the discussion of V_{QH} , the states with $\mathcal{R} \geq 3$ ($L = 0, 2, 3, 4$, and 6) have the lowest energy within this band, but the Laughlin $\nu_{\text{QH}} = 1/5$ state with $\mathcal{R} \geq 5$ is not the GS and the system at $\nu = 4/13$ is compressible.

Since the GS's at $\nu = 4/11$ or $4/13$ are not valid parent states (QP Laughlin states), the analysis of states at ν near $4/11$ or $4/13$ in terms of their daughter QP's is not possible.

This is demonstrated in Figs. 4(c,d), where the states that would contain two QE's in the $\nu=4/11$ each with $l_{\text{QE}}=3/2$ ($L=0$ and 2) and two QE's in the $\nu=4/13$ each with $l_{\text{QE}}=2$ ($L=1$ and 3), do not have lowest energy.

The low-lying states in each of the spectra in Figs. 4(e,f) contain three QP's each with $l_{\text{QP}}=3$ in a valid incompressible higher-level hierarchy state ($L=0, 2, 3, 4,$ and 6). The interaction of QE's in the $\nu=2/5$ state and of QH's in the $\nu=3/7$ state is similar, as those particles are connected through the particle-hole symmetry. Also, since the appropriate pseudopotential in Fig. 3(a) (for $N=10$) increases with increasing \mathcal{R} , we expect the standard atomic Hund rule to hold, i.e., the lowest energy state should have maximum allowed L within the lowest-energy band of three QP's. Indeed, the $L=6$ state is the GS of both systems, while the states at $L=0$ predicted by the hierarchy picture ($\nu=7/17$ and $8/19$) have higher energy.

Numerical tests of other fractions become difficult due to increasing size of the system. However, one can diagonalize the Hamiltonian of interacting QP's in a given parent states using their known single-particle energies ε_{QP} (the values for QP's in Laughlin $\nu=1/3$ and $1/5$ states can be found in Refs. 25 and 35) and pseudopotentials $V_{\text{QP}}(\mathcal{R})$, and obtain approximate lowest-energy levels of an underlying (larger) electron system (with respect to the energy E_0 of the parent incompressible state).⁵⁰ The error made in such an approximate calculation is due to neglected scattering processes involving objects other than the specified QP's (e.g., polarization of the parent state through creation of additional QE-QH pairs, etc.). At least for states with largest ε_{QP} (compared to the strength of QP interactions), this error is expected to be small, which validates the tests of incompressibility of their daughter states.

The results of such tests for a few different systems are shown in Fig. 5. In all frames, the energy is measured from the energy of the parent ($\nu=1/3$) state and λ is the magnetic length in the parent state. In Figs. 5(a,b), the approximate spectra (full dots) are overlaid with exact energies (pluses) obtained by diagonalization of the full electron Hamiltonian. Clearly, both for interacting QE's and QH's, the approximate calculation gives the lowest-lying states with negligible error (most of which is due to different magnetic lengths in the daughter and parent states and can be corrected; error due to neglected scattering processes is hardly visible). This agreement proves that the low-lying states in FQH systems indeed contain QP's characterized by certain level degeneracy and interaction (weakly dependent on the QP number), and validates use of the approximate calculation for larger systems. The data in Fig. 5(a) are by itself another example, showing that QE's in Laughlin $\nu=1/3$ state do not form a separate band of states with $\mathcal{R}\geq 3$ (these would be states with $L=3/2, 5/2,$ and $9/2$). Similarly, Fig. 5(b) shows that QH's form a band with $\mathcal{R}\geq 3$ ($L=3/2, 5/2, 7/2, 9/2, 11/2,$ and $15/2$), but do not form a band with $\mathcal{R}\geq 5$ (here, one multiplet with $L=3/2$ that would correspond to a QE in the $\nu=4/13$ state).

Figures 5(c,d,e,f) show approximate spectra of larger systems. Figure 5(c) shows no band corresponding to two QE's in the $\nu=4/11$ state of 14 electrons (these would be states at $L=1$ and 3), Fig. 5(d) shows a band corresponding to two QE's in the $\nu=2/7$ state of ten electrons [$L=1, 3,$ and 5;

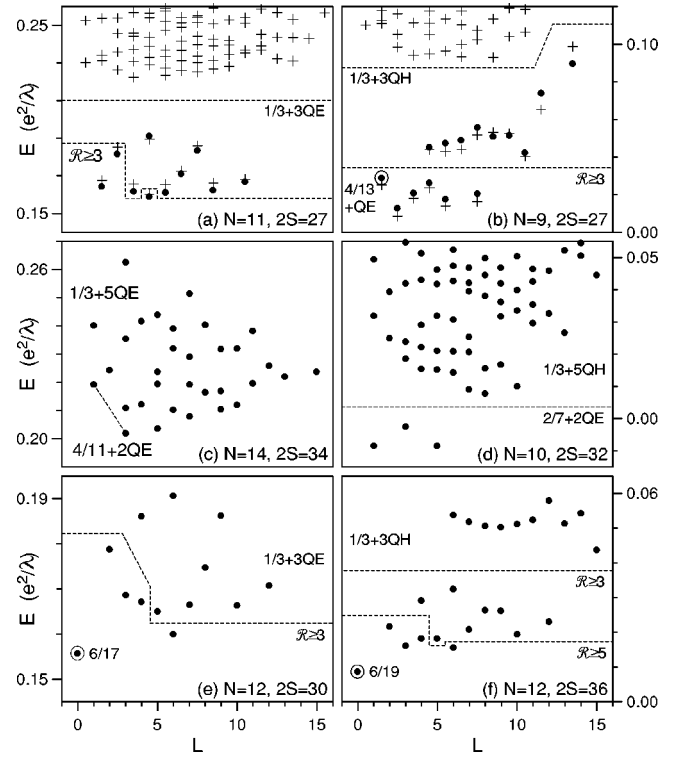

FIG. 5. Few electron energies E measured from the energy of the parent $\nu=1/3$ state as a function of total angular momentum L , obtained in exact diagonalization in terms of Laughlin quasiparticles (left) or quasiholes (right) of the $\nu=1/3$ state interacting through appropriate pseudopotentials plotted in Fig. 2. Dashed lines mark energy bands predicted by the hierarchy picture assuming short range of all involved quasiparticle interactions. Pluses in frames (a) and (b) mark exact energies obtained by diagonalizing electron-electron interaction, as in Fig. 4.

this is the QE pseudopotential like those for $N=6$ and 8 in Fig. 3(c)], Fig. 5(e) shows no band of (Laughlin $\nu=1/3$) QE states with $\mathcal{R}\geq 3$ (these would be states at $L=0, 2, 3, 4,$ and 6), and an incompressible $\nu=6/17$ state of twelve electrons corresponding to $\nu_{\text{QE}}=1/5$, and Fig. 5(f) shows a band of (Laughlin $\nu=1/3$) QH states with $\mathcal{R}\geq 3$, no band with $\mathcal{R}\geq 5$ (these would be states at $L=0, 2, 3, 4,$ and 6), and an incompressible $\nu=6/19$ state of twelve electrons corresponding to $\nu_{\text{QE}}=1/7$.

The $\nu=6/17$ and $6/19$ states of twelve electrons in Figs. 5(e,f) are the only non-Jain hierarchy states we have tested numerically that are predicted to be (incompressible) $L=0$ GS's based on pseudopotentials in Figs. 2 and 3 and that contain at least three QP's. However, because of the particle-hole symmetry and the similarity of different QP pseudopotentials (see Figs. 2 and 3), the numerical evidence for valid $L=0$ hierarchy ground states at $\nu=6/17$ and $6/19$ (in a twelve-electron system) suggests stability of some other hierarchy states, e.g. at $\nu=6/29, 6/31, 9/23,$ and $11/39$ (all states with question marks in Fig. 1), at least in finite systems with appropriate electron number (see next section).

VI. PREDICTIONS FOR INFINITE SYSTEMS

The extrapolation of our numerical results in order to predict stability of different hierarchical states in infinite sys-

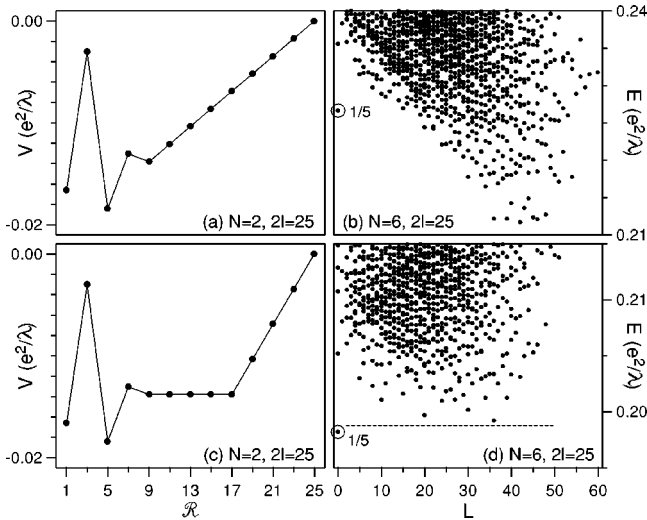

FIG. 6. Left: Model pseudopotentials $V(\mathcal{R})$, equal to V_{QE} in Fig. 2(a) ($N=11$) for $\mathcal{R} \leq 9$ and increasing to zero for \mathcal{R} increasing to 25. Right: Energies E of six particles each with single-particle energy ε_{QE} (for $\nu=1/3$ state of $N=11$ electrons) and interacting through pseudopotentials on the left, as a function of total angular momentum L .

tems must be done very carefully. The calculations⁴⁶ show that the interaction of QP's in a Laughlin parent state is not generally repulsive. The pseudopotential $V_{QP}(\mathcal{R})$ is obtained by subtraction of two appropriate QP energies $2\varepsilon_{QP}$ from energies $E(\mathcal{R})$ in Figs. 2 and 3. For example, for the $\nu=1/3$ parent state, the only positive pseudopotential parameter is $V_{QH}(1)$, and all others [$V_{QH}(\mathcal{R})$ for $\mathcal{R} \geq 3$ and $V_{QE}(\mathcal{R})$ for all \mathcal{R}] are negative. Since $V_{QP}(\mathcal{R})$ at large \mathcal{R} (large distance) is expected to vanish, it must also increase above all the values at small \mathcal{R} except for $V_{QH}(1)$. This brings out the question if our prediction of incompressible states at, e.g., $\nu=6/17$ ($\nu_{QE}=1/5$) or $\nu=6/19$ ($\nu_{QH}=1/7$), verified numerically for twelve electrons [Figs. 5(e,f)] remains valid for an infinite system. We have calculated energy spectra of six particles at filling $\nu=1/5$ ($2l=25$), interacting through pseudopotentials that for $\mathcal{R} \leq 9$ were equal to $V_{QE}(\mathcal{R})$ for $N=11$ in Fig. 2(a), vanished at $\mathcal{R}=25$, and behaved in a number of different ways for $9 < \mathcal{R} < 25$. As shown in Fig. 6, the $L=0$ hierarchy state is always the lowest-energy state in the low- L part of the spectrum, but whether it is an absolute GS depends on how quickly $V_{QP}(\mathcal{R})$ goes to zero with increasing \mathcal{R} . This is a consequence of the following operator identity:^{24,25}

$$\sum_{i < j} \hat{L}_{ij}^2 = \hat{L}^2 + N(N-2) \hat{l}^2, \quad (7)$$

which relates total (L) and pair (\hat{L}_{ij}) angular momenta of a system of N particles in a shell of angular momentum l . The states with larger L have (on the average) larger values of L_{ij} and thus, if $V(\mathcal{R})$ increases with increasing \mathcal{R} , lower energy.

The exact numerical calculation of $V_{QP}(\mathcal{R})$ for $\mathcal{R} \gg 9$, i.e., for $l_{QP} \gg 5$, seems impossible (calculations for $N=11$ with $l_{QE}=5$ and $l_{QH}=6$ already required diagonalization of matrices with dimensions of about 10^6 and 3×10^6 , respectively), and thus the only valid test of stability of states like

$\nu=6/17$ or $6/19$ might be experiment. However, since $V_{QP}(\mathcal{R})$ for a large (infinite) system should be virtually zero for all \mathcal{R} 's above a certain critical value, it is unlikely that these GS's will be incompressible in the thermodynamic limit. This would explain why (to our knowledge), no such states have been observed.

The above arguments most likely eliminate all daughter states derived from Laughlin $\nu=1/m$ parents with $\nu_{QE}=1/5$ and $\nu_{QH}=1/7$ as possible incompressible GS's, leaving only those with $\nu_{QE}=1$ and $\nu_{QH}=1/3$. The latter ones are incompressible, because they either correspond to a filled shell ($\nu_{QE}=1$) or avoid the (only) repulsive pseudopotential parameter $V_{QH}(1) > 0$ ($\nu_{QH}=1/3$). A quick look at the pseudopotentials in Fig. 3 is enough to find that the incompressible states on higher levels of hierarchy can only have $\nu_{QE}=1$. It is easy to check (see also Fig. 1) that fractions generated in this way belong to the Jain sequence obtained from Eq. (1) for integer ν^* . This explains why the hierarchy fractions from outside this sequence have not been observed experimentally,¹⁵⁻¹⁸ even though numerical results for finite systems presented here might suggest that states like $\nu=6/17$ or $6/19$ are incompressible.

Let us stress that the fact that valid hierarchy states (i.e., states with Laughlin-like correlations of appropriate Laughlin QP's) occur only at the Jain sequence of filling factors obviously does not contradict occurrence of FQH effect at other fractions. However, the correlations in other possible FQH states, the origin of their incompressibility, and their elementary excitations must be different. Examples of observed¹⁵ nonhierarchy FQH states include ones at $\nu=7/3$ (calculations show^{25,48} that it is not a Laughlin-like $\nu=1/3$ state in the first excited LL) and $\nu=5/2$.

VII. COMPARISON WITH CF PICTURE

The mean-field CF picture correctly predicts not only the incompressible states at the Jain sequence of filling factors, but also the low-lying bands of states at any value of N and $2S$. However, neither its original justification based on cancellation between Coulomb and CS interactions beyond the mean field nor the use of higher LL's in construction of CF wave functions can be accepted as complete understanding of this success.

If the effective CF magnetic field is non-negative ($2S^* \geq 0$) and the effective CF filling factor is less or equal than one ($\nu^* \leq 1$) the CF picture selects out of the total Hilbert space \mathcal{H} the subspace \mathcal{H}_p , where $2p$ is the number of bound (attached) flux quanta.²³⁻²⁵ From Eq. (4) and Fig. 1 it is clear that the entire sequence of Jain fractions corresponds to valid hierarchy states, obtained by the QE filling of $\nu_{QE}=0$ or 1 on any level of hierarchy and/or the QH filling of $\nu_{QH}=1/3$ on the first level (QH's in the principal Laughlin $\nu=1/m$ state). Note that CF states obtained with $2p$ bound flux quanta for which $2S^*$ is positive are derived from the $\nu_{QE}=1$ daughter of the Laughlin $\nu=(2p+1)^{-1}$ state, while those for which $2S^*$ is negative come from the $\nu_{QH}=1/3$ daughter of the Laughlin $\nu=(2p-1)^{-1}$ state. The explicit hierarchy wave functions can also be constructed^{51,52} without introducing higher LL's excitations. As demonstrated for few-electron systems,⁵³ the (valid) hierarchy and CF wave functions are nearly identical. Another qualitative success of the CF pic-

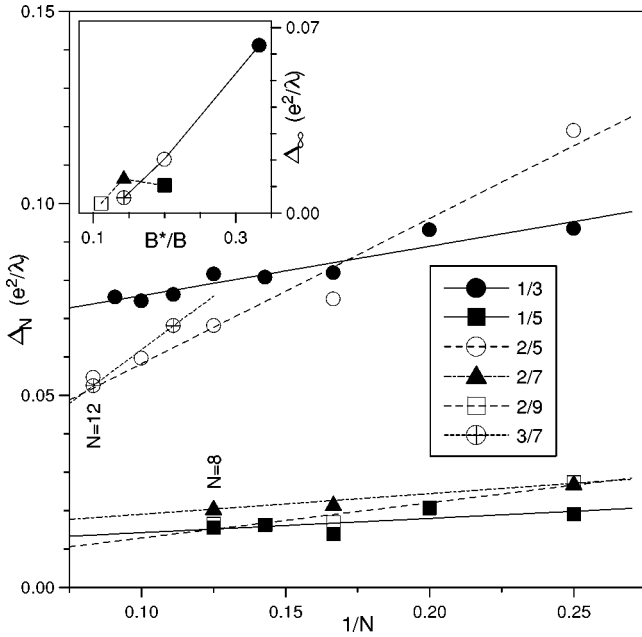

FIG. 7. Excitation gaps Δ_N of a few valid hierarchy states calculated in numerical diagonalization of N electrons and plotted as a function of $1/N$. Inset: limiting values Δ_∞ as a function of effective composite Fermion magnetic field B^* .

ture, the description of higher bands in the energy spectrum in terms of excitations between CF LL's, in the hierarchy picture corresponds to the creation of additional QE-QH pairs in the parent state.¹¹

One of the main results used as a direct experimental evidence for the existence of CF's—the observation^{54,55} of geometric resonances and divergence of the CF cyclotron radius at $B^* \rightarrow 0$ —does not contradict the hierarchy picture where the fractionally charged⁵⁶ relevant QP's move in a bare external field B so that the cyclotron radius coincides with the one of the CF's moving in an effective field B^* . Read⁵⁷ and Pasquier and Haldane⁵⁸ have shown that these QP's are electric dipoles whose charge vanishes at $\nu = 1/2$. The relation between the descriptions of the half-filled state in terms of CF's and dipoles is discussed in Ref. 59.

Another result⁶⁰ seemingly proving the formation of CF LL's is the linear dependence of the excitation gap of Jain states on the effective magnetic field B^* . In Fig. 7 we plot the gaps Δ_N calculated numerically for a few most prominent hierarchy/Jain states as a function of the inverse electron number, $1/N$. The limiting values Δ_∞ are plotted in the inset as a function of $B^*/B = 1 - 2p\nu$. The gaps of states obtained from Eq. (1) for $p = 1$ ($\nu = 1/3, 2/5, 3/7, \dots$) fall on a straight line versus B^*/B (as first observed by Du *et al.*;⁶⁰ note, however, that the linear extrapolation to $B^* = 0$ gives negative gaps, also in agreement with experiment of Du *et al.*⁶⁰). However, it is not so for Jain $p = 2$ states at $\nu = 1/5, 2/7$, and $2/9$. In particular, the gap of the $\nu = 2/7$ state seems to be larger than that of the $\nu = 1/5$ state. While this result may be difficult to accept in the CF picture, it is by no means surprising in the hierarchy picture where the relevant QP's in the two states are different and interact through different pseudopotentials (see Figs. 1–3).

The mean-field CF picture and the present hierarchy pic-

ture are equivalent because they both use correct degeneracy of excitations, g_{QE} and g_{QH} , for the chosen (fermionic) statistics. The CF picture makes no use of the form of single particle wavefunctions in excited LL's; an effective magnetic field is just another way to obtain correct g_{QE} and g_{QH} . However, the authors believe that the understanding of incompressible states at Jain filling factors in terms of hierarchy of Laughlin excitations and involved QP pseudopotentials has a number of advantages over the CF picture. It does not use such puzzling concepts as flux binding, depends explicitly and in a known way on the form of electron-electron interaction, which enables predicting its applicability to systems with modified interactions (higher LL's, finite well width, etc.), and predicts correct energy gaps in terms of interaction parameters rather than arbitrary effective cyclotron energy. The hierarchy picture is also more physically intuitive and makes the origin of incompressibility of Jain states more clear. Moreover, it gives better understanding of why no other fractions are experimentally observed, even though some (e.g., $\nu = 6/17$ and $6/19$) are found in finite size numerical calculations.

VIII. CONCLUSION

We have calculated pseudopotentials of the interaction between quasiparticles, arising in the hierarchy picture of incompressible FQH states. Based on the analysis of these pseudopotentials, it is explained why no hierarchy states with filling factors ν from outside the Jain sequence occur in an infinite system, and thus why none have been observed experimentally. Compressibility of $\nu = 4/11$ and $4/13$ states is demonstrated. Laughlin-like hierarchy states other than Jain states are found at $\nu = 6/17$ and $6/19$ in finite-size numerical calculations. However, it is argued that the system at these fractions (and other non-Jain fractions with question marks in Fig. 1) will undergo a transition into a compressible phase when its size is increased.

The descriptions of FQH states in terms of mean-field CF's and hierarchy of Laughlin excitations are compared. It is explained why, despite no rigorous justification of the CF assumption of flux (or vortex) binding, the CF predictions and the valid predictions of the hierarchy picture are (qualitatively) equivalent. In our analysis we used fermionic statistics of quasiparticles. However, our results are independent of these statistics and remain valid for hierarchy pictures formulated in terms of bosons or anyons.

ACKNOWLEDGMENTS

This work was supported in part by the Materials Research Program of Basic Energy Sciences, U.S. Department of Energy.

- ¹D.C. Tsui, H.L. Störmer, and A.C. Gossard, Phys. Rev. Lett. **48**, 1559 (1982).
- ²R. Laughlin, Phys. Rev. Lett. **50**, 1395 (1983).
- ³*The Quantum Hall Effect*, edited by R. E. Prange and S. M. Girvin (Springer-Verlag, New York, 1987).
- ⁴H.L. Störmer, D.C. Tsui, and A.C. Gossard, Rev. Mod. Phys. **71**, S298 (1999).
- ⁵K. von Klitzing, G. Dorda, and M. Pepper, Phys. Rev. Lett. **45**, 494 (1980).
- ⁶R. Laughlin, Phys. Rev. B **23**, 5631 (1981).
- ⁷F.D.M. Haldane, Phys. Rev. Lett. **51**, 605 (1983).
- ⁸R.B. Laughlin, Surf. Sci. **142**, 163 (1984).
- ⁹B.I. Halperin, Phys. Rev. Lett. **52**, 1583 (1984).
- ¹⁰J.K. Jain and V.J. Goldman, Phys. Rev. B **45**, 1255 (1992).
- ¹¹P. Sitko, K.-S. Yi, and J.J. Quinn, Phys. Rev. B **56**, 12 417 (1997).
- ¹²N. Read, Phys. Rev. Lett. **65**, 1502 (1990).
- ¹³Y.J. Chen, Phys. Rev. B **56**, 7941 (1992).
- ¹⁴J. Yang, Phys. Rev. B **50**, 11 196 (1994).
- ¹⁵R.L. Willet, J.P. Eisenstein, H.L. Störmer, D.C. Tsui, A.C. Gossard, and J.H. English, Phys. Rev. Lett. **59**, 1776 (1987).
- ¹⁶J.R. Mallet, R.G. Clark, R.J. Nicholas, R.L. Willet, J.J. Harris, and C.T. Foxon, Phys. Rev. B **38**, 2200 (1988).
- ¹⁷T. Sajoto, Y.W. Suen, L.W. Engel, M.B. Santos, and M. Shayegan, Phys. Rev. B **41**, 8449 (1990).
- ¹⁸I.V. Kukushkin, R.J. Haug, K. von Klitzing, and K. Ploog, Phys. Rev. Lett. **72**, 736 (1994).
- ¹⁹J. Jain, Phys. Rev. Lett. **63**, 199 (1989).
- ²⁰A. Lopez and E. Fradkin, Phys. Rev. B **44**, 5246 (1991).
- ²¹B.I. Halperin, P.A. Lee, and N. Read, Phys. Rev. B **47**, 7312 (1993).
- ²²F.D.M. Haldane and E.H. Rezayi, Phys. Rev. Lett. **60**, 956 (1988).
- ²³A. Wójs and J.J. Quinn, Solid State Commun. **108**, 493 (1998).
- ²⁴A. Wójs and J.J. Quinn, Solid State Commun. **110**, 45 (1999).
- ²⁵A. Wójs and J.J. Quinn, cond-mat/9903145 (unpublished).
- ²⁶A. Wójs, P. Hawrylak, and J.J. Quinn, Physica B **256-258**, 490 (1998).
- ²⁷A. Wójs, P. Hawrylak, and J.J. Quinn, Phys. Rev. B **60**, 11 661 (1999).
- ²⁸A. Wójs, I. Szlufarska, K.-S. Yi, and J.J. Quinn, Phys. Rev. B **60**, R11 273 (1999).
- ²⁹C. Lanczos, J. Res. Natl. Bur. Stand. **45**, 255 (1950); R. Haydock, Solid State Phys. **35**, 215 (1980).
- ³⁰R. Laughlin, Phys. Rev. B **27**, 3383 (1983).
- ³¹F.D.M. Haldane and E.H. Rezayi, Phys. Rev. B **31**, 2529 (1985).
- ³²A. Wójs and J.J. Quinn, Physica E (Amsterdam) **3**, 181 (1998).
- ³³P. A. M. Dirac, Proc. R. Soc. London, Ser. A **133**, 60 (1931).
- ³⁴T.T. Wu and C.N. Yang, Nucl. Phys. B **107**, 365 (1976); Phys. Rev. D **16**, 1018 (1977).
- ³⁵G. Fano, F. Ortolani, and E. Colombo, Phys. Rev. B **34**, 2670 (1986).
- ³⁶Excitations other than containing additional QE-QH pairs are possible, but they have higher energy.
- ³⁷F. Wilczek, *Fractional Statistics and Anyon Conductivity* (World Scientific, Singapore, 1990).
- ³⁸G.S. Canright, S.M. Girvin, and A. Brass, Phys. Rev. Lett. **63**, 2291 (1989).
- ³⁹X.C. Xie, S. He, and S. Das Sarma, Phys. Rev. Lett. **66**, 389 (1991).
- ⁴⁰S. He, X.-C. Xie, and F.-C. Zhang, Phys. Rev. Lett. **68**, 3460 (1992).
- ⁴¹Note that the present definition of \mathcal{R} is slightly different from that in Refs. 23 and 25.
- ⁴²A. de Shalit and I. Talmi, *Nuclear Shell Theory* (Academic Press, New York, 1963).
- ⁴³R. D. Cowan, *The Theory of Atomic Structure and Spectra* (University of California Press, Berkeley, 1981).
- ⁴⁴J.N. Ginocchio and W.C. Haxton, Phys. Rev. Lett. **77**, 1568 (1996).
- ⁴⁵P. Béran and R. Morf, Phys. Rev. B **43**, 12 654 (1991).
- ⁴⁶S.N. Yi, X.M. Chen, and J.J. Quinn, Phys. Rev. B **53**, 9599 (1996).
- ⁴⁷M. Shayegan, J. Jo, Y.W. Suen, M. Santos, and V.J. Goldman, Phys. Rev. Lett. **65**, 2916 (1990).
- ⁴⁸A.H. MacDonald and S.M. Girvin, Phys. Rev. B **33**, 4009 (1986); **33**, 4414 (1986).
- ⁴⁹F.D.M. Haldane and E.H. Rezayi, Phys. Rev. Lett. **54**, 237 (1985).
- ⁵⁰P. Sitko, S.N. Yi, K.-S. Yi, and J.J. Quinn, Phys. Rev. Lett. **76**, 3396 (1996).
- ⁵¹A.H. MacDonald, G.C. Aers, and M.W.C. Dharma-wardana, Phys. Rev. B **31**, 5529 (1985).
- ⁵²J. Yang, Phys. Rev. B **49**, 16 765 (1994).
- ⁵³C.L. de Souza Batista and D. Li, Phys. Rev. B **55**, 1582 (1997).
- ⁵⁴R.L. Willet, R.R. Ruel, K.W. West, and L.N. Pfeiffer, Phys. Rev. Lett. **71**, 3846 (1993).
- ⁵⁵W. Kang, H.L. Störmer, L.N. Pfeiffer, K.W. Baldwin, and K.W. West, Phys. Rev. Lett. **71**, 3850 (1993).
- ⁵⁶R.G. Clark, J.R. Mallet, S.R. Haynes, J.J. Harris, and C.T. Foxon, Phys. Rev. Lett. **60**, 1747 (1988).
- ⁵⁷N. Read, Semicond. Sci. Technol. **9**, 1859 (1994); Surf. Sci. **361/362**, 7 (1996).
- ⁵⁸V. Pasquier and F.D.M. Haldane, Nucl. Phys. B **516**, 719 (1998).
- ⁵⁹A. Stern, B.I. Halperin, F. von Oppen, and Steven H. Simon, Phys. Rev. B **59**, 12 547 (1999).
- ⁶⁰R.R. Du, H.L. Störmer, D.C. Tsui, L.N. Pfeiffer, and K.W. West, Phys. Rev. Lett. **70**, 2944 (1993).