

Experimental many-pairs nonlocalityHou Shun Poh,¹ Alessandro Cerè,¹ Jean-Daniel Bancal,² Yu Cai,¹ Nicolas Sangouard,²
Valerio Scarani,^{1,3} and Christian Kurtsiefer^{1,3}¹Centre for Quantum Technologies, National University of Singapore, 3 Science Drive 2, Singapore 117543²Department of Physics, University of Basel, Klingelbergstrasse 82, 4056 Basel, Switzerland³Department of Physics, National University of Singapore, 2 Science Drive 3, Singapore 117551

(Received 5 April 2017; published 1 August 2017)

Collective measurements on large quantum systems together with a majority voting strategy can lead to a violation of the Clauser-Horne-Shimony-Holt Bell inequality. In the presence of many entangled pairs, this violation decreases quickly with the number of pairs and vanishes for some critical pair number that is a function of the noise present in the system. Here we show that a different binning strategy can lead to a more substantial Bell violation when the noise is sufficiently small. Given the relation between the critical pair number and the source noise, we then present an experiment where the critical pair number is used to quantify the quality of a high visibility photon pair source. Our results demonstrate nonlocal correlations using collective measurements operating on clusters of more than 40 photon pairs.

DOI: [10.1103/PhysRevA.96.022101](https://doi.org/10.1103/PhysRevA.96.022101)**I. INTRODUCTION**

The ability of detecting single quanta, already developed for some decades, is a crucial feature of experimental quantum technologies, and the whole thinking in quantum information science usually relies on it [1]. This notwithstanding, recent studies have considered situations in which single-quanta control and detection are *not* available. For instance, in many-body systems measurements are performed collectively—the same measurement is applied to all particles and the outcome produced is extensive in the system size—so single quanta identification is lost. It is also common in such systems to have access to only few-body correlators, in which case single-quanta resolution is also lost [3]. Another example where single-quanta detection is not available is when quantum light is detected by biological systems [4–7].

Prompted by interest in these systems, it is relevant to study what happens to the violation of Bell's inequalities. Several restrictions have been highlighted in the limit of large numbers of particles. For instance, Bell inequalities cannot be violated if only few-body collective observables are measured [8], unless one adds assumptions [9,10]. In a many-pair scenario, high-order collective measurements are also unable to lead to a Bell violation as soon as some realistic coarse-graining is present [11]. At the same time, it is also known that the ability to address single quanta is not necessary for violating a Bell inequality where n particles are subjected to collective measurement processed through majority voting [12]. In this case, however, the observed violation is known to decrease quickly as a function of the number of particles.

In this paper, we show that substantial violation can be obtained in the presence of collective measurements for an arbitrary number of particles by using a parity binning strategy. We discuss the resistance to noise of this Bell violation as a function of the cluster size n , the number of pairs of particles collectively measured, and compare it with the one obtained in the previous approach. In each case we find that the maximal cluster size n_c for which a Bell violation can

be obtained is sensitive to experimental imperfections and proves to be a good figure of merit to certify the quality of a high-visibility source [13–15]. From this insight, we perform a proof-of-principle experiment using a very high-quality source of photon pairs and demonstrate nonlocal correlations with collective measurements operating on clusters of up to 41 photon pairs.

II. THEORY**A. The many-pair scenario**

Consider a source that produces n independent pairs of correlated particles—in particular, particles belonging to different pairs are *a priori* distinguishable [12]. One particle of each pair is sent to party Alice and the other to party Bob. Each party submits all its n particles to the same single-particle measurement, labeled x for Alice and y for Bob. Alice's (Bob's) particle from the i th pair returns the outcomes a_{xy}^i (b_{xy}^i).

We focus on the case where each party performs one of two measurements ($x, y \in \{1, 2\}$) and the single-particle outcome is binary ($a, b \in \{0, 1\}$). The correlations observed in this scenario are nonlocal if and only if they violate a Bell inequality for two inputs and 2^n outputs per party. For a given correlation, locality can be checked by a linear program, but the hope of completely solving the local polytope for large n is slim, since the full list of inequalities is already unknown for $n = 2$ [16,17]. The number of liftings (that is, loosely speaking, the number of different versions) of the Clauser-Horne-Shimony-Holt (CHSH) Bell inequality alone is exponential in 2^n .

We consider a family of measurements indexed by a single angle β as follows:

$$\begin{aligned} A_1 &= \sigma_z, & A_2 &= \cos(2\beta)\sigma_z + \sin(2\beta)\sigma_x, \\ B_1 &= \cos\beta\sigma_z + \sin\beta\sigma_x, & B_2 &= \cos\beta\sigma_z - \sin\beta\sigma_x. \end{aligned} \quad (1)$$

When applied to the Werner state

$$\rho = V|\psi^-\rangle\langle\psi^-| + (1-V)\mathbb{I}/4, \quad (2)$$

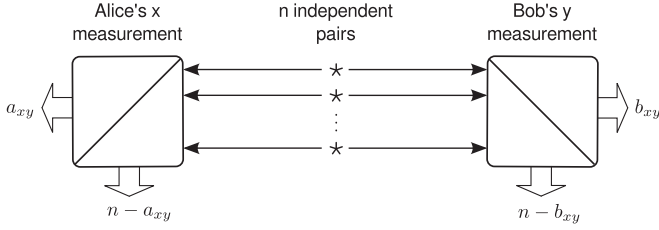

FIG. 1. Many-pair experiment scheme: n independent pairs are shared by two parties in each round. Alice (Bob) applies measurement x (y) to all of her (his) particles. When the label of each particle is ignored, the outcome of each party can be described by variables a_{xy} and b_{xy} admitting $n + 1$ possible values.

where $|\psi^-\rangle = \frac{1}{\sqrt{2}}(|01\rangle - |10\rangle)$ is the maximally entangled state of two qubits, the statistics of a single pair are described by the correlators

$$E_{11} = E_{12} = E_{21} = V \cos \beta, \quad E_{22} = V \cos(3\beta), \quad (3)$$

where $E_{xy} = \text{Prob}(a_{xy} = b_{xy}) - \text{Prob}(a_{xy} \neq b_{xy})$, and uniformly random marginals.

So far, no assumption has been made, but now we assume that each party is not able to observe the entire string of outcomes, but only their sum:

$$a_{xy} = \sum_{i=1}^n a_{xy}^i, \quad b_{xy} = \sum_{i=1}^n b_{xy}^i, \quad (4)$$

with $a_{xy}, b_{xy} \in \{0, 1, \dots, n\}$. In other words, in a Stern-Gerlach picture, each party can count how many particles take each port, but is unable to sort out which of their particles was correlated with which of the other party's (see Fig. 1).

To simplify the test for the Bell violation, we introduce a processing of the data so that $a_{xy} \rightarrow a'_{xy}$ and $b_{xy} \rightarrow b'_{xy}$, with $a'_{xy}, b'_{xy} \in \{+1, -1\}$, bringing us back to a two-input and two-output scenario, in which the only relevant Bell inequality is the CHSH inequality

$$S_n = E_{11}^{(n)} + E_{12}^{(n)} + E_{21}^{(n)} - E_{22}^{(n)} \leq 2, \quad (5)$$

where $E_{xy}^{(n)} = \text{Prob}(a'_{xy} = b'_{xy}) - \text{Prob}(a'_{xy} \neq b'_{xy})$. If the correlations of the primed variables violate the CHSH inequality, certainly those of the original unprimed variables violated some Bell inequality (surely the corresponding lifting of the CHSH inequality [18]). Of course, information has been lost in the binning, so the converse is not true.

Specifically, we consider two such local binnings, majority vote and parity. For each of them, we compute the amount of violation achievable as a function of V and n . We then estimate a lower bound on the Werner state visibility, or the critical visibility V_c , as a function of the number of pairs n at which a violation is observed. Conversely, for a system with known V we define n_c as the largest n for which it is still possible to observe a violation for each of the binning models.

B. Majority vote

The first binning, *majority vote*, is obtained by comparing the observed output to a fixed threshold $t = n/2$. If the outcome is larger than t , we produce $+1$, otherwise we

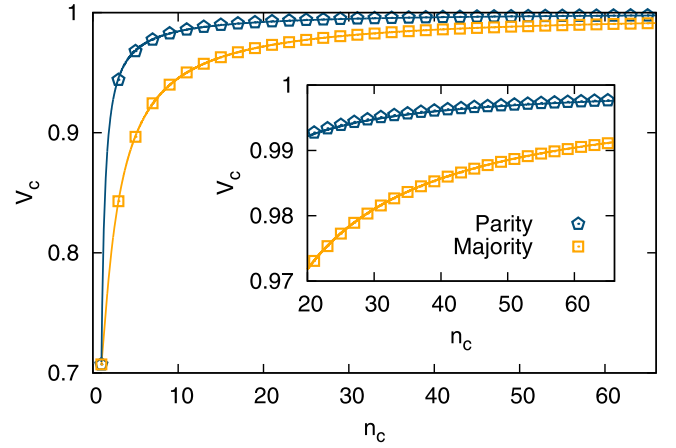

FIG. 2. Critical visibility V_c for majority vote and parity binning as a function of n_c . Points are obtained numerically; the continuous lines are the fitting functions described in Eqs. (7) and (13).

produce -1 , i.e.,

$$a'_{xy} = \text{sgn}(a_{xy} - t). \quad (6)$$

Previous numerical studies suggest that the violation (with optimized measurement setting) of the CHSH inequality after such binning decreases roughly as $\sim 1/\sqrt{n}$. For every odd value of $n \lesssim 65$ we numerically derive the value of β_n^{\max} that provides the larger value of S and use it to compute the minimal visibility for which inequality (5) is violated. Within the considered range, these numerical results are well approximated by the following expression (see Fig. 2):

$$V_c^{\text{maj}}(n) \simeq 1 - \frac{0.5807}{n} + \frac{0.3479}{n^2} - \frac{0.06002}{n^3}. \quad (7)$$

For instance, a violation with $n = 21$ pairs of Werner states requires a visibility of $V \geq 97.31\%$ [19]; a visibility of $V \geq 99.08\%$ still achieves a violation until $n = 63$ pairs.

C. Parity binning

Let us now consider the parity binning:

$$a'_{xy} = (-1)^{a_{xy}} \quad (8)$$

and similarly for Bob. Recalling Eq. (4), the bipartite correlator $E_{xy}^{(n)} = \langle a'_{xy} b'_{xy} \rangle$ is

$$\begin{aligned} E_{xy}^{(n)} &= \langle (-1)^{\sum_i a_{xy}^i} (-1)^{\sum_i b_{xy}^i} \rangle \\ &= \left\langle \prod_i (-1)^{a_{xy}^i + b_{xy}^i} \right\rangle = (E_{xy})^n. \end{aligned} \quad (9)$$

In the absence of noise, i.e., $V = 1$,

$$S_n = 3 \cos^n \beta - \cos^n(3\beta). \quad (10)$$

Remarkably, in this case, the CHSH violation does not tend to 2 for arbitrarily large n . From the expression of S_n we derive an asymptotic violation of $S_\infty > 2$. Choosing $\beta = \frac{\beta_0}{\sqrt{n}}$, we find $S_n \xrightarrow{n \rightarrow \infty} 3e^{-\beta_0^2/2} - e^{-9\beta_0^2/2}$, whose maximum is $S_\infty = 8 \times 3^{-9/8} \simeq 2.32$ obtained for $\beta_0 = \sqrt{\ln 3}/2 \simeq 0.524$.

The situation changes when we extend Eq. (10) to consider the case of $V < 1$:

$$S_n(V) = V^n S_n(V = 1). \quad (11)$$

It is evident how the asymptotic violation disappears with the least amount of white noise, $V^n S_n(V = 1) \xrightarrow{n \rightarrow \infty} 0$ for any $V < 1$. Nevertheless, for every n there exists a critical visibility $V_c(n)$, such that violation will be observed if $V > V_c(n)$. The condition $S_n \simeq 8 \times 3^{-9/8} V^n \simeq 8 \times 3^{-9/8} [1 - n(1 - V)] = 2$ gives

$$V_c^{\text{parity}}(n) \simeq 1 - \frac{1 - 3^{9/8}/4}{n} \simeq 1 - \frac{0.14}{n}. \quad (12)$$

This expression, as opposed to Eq. (7), is not a numerical guess, but an analytic approximation in the high-visibility regime.

Equation (12) is only optimal in the limit of large n . For a finite n , a numerical computation over the angle β_n^{max} can be used to find the optimal critical visibility as a function of the size of the cluster n . For $n \lesssim 65$ the numerical results are well approximated by the following expression:

$$V_c^{\text{par}}(n) \simeq 1 - \frac{0.1584}{n} + \frac{0.03987}{n^2} - \frac{0.1743}{n^3}. \quad (13)$$

A violation with $n = 4$ pairs requires a visibility higher than $V \geq 96\%$; a visibility of $V \geq 99\%$ produces a violation with at most $n = 15$ pairs.

In Fig. 2 we compare V_c as a function of n_c for the majority vote and parity binnings. From the comparison, we notice that for any fixed n the majority binning tolerates smaller values of V insofar as the possibility of violation is concerned. However, the amount of violation is different for the two cases: in the case of majority voting, the violation quickly decreases with the number of pairs as $\sim 1/\sqrt{n}$, whereas it only decreases linearly $\sim S_0 - Cn$ in the parity case, with $C \propto (1 - V)$ approaching 0 when V approaches 1. Therefore, for V high enough, parity exhibits higher violations for the same values of n . This behavior starts at $V \gtrsim 99.4\%$ (see Fig. 7 for the amount of Bell violation with parity binning).

III. EXPERIMENT

A. Experimental setup

In our experiment (see Fig. 3), the output of a grating-stabilized laser diode (LD, central wavelength 405 nm) passes through a single mode optical fiber (SMF) for spatial mode filtering, and is focused to a beam waist of $80 \mu\text{m}$ into a 2-mm-thick BBO crystal cut for type-II phase matching. There photon pairs are generated via spontaneous parametric down-conversion (SPDC) in a noncollinear configuration, with a half-wave plate ($\lambda/2$) and a pair of compensation crystals (CC) to take care of the temporal and transversal walk-off [19]. Two spatial modes (A, B) of down-converted light, defined by the SMFs for 810 nm, are matched to the pump mode to optimize the collection [20]. In type-II SPDC, each down-converted pair consists of an ordinary and an extraordinarily polarized photon, corresponding to horizontal (H) and vertical (V) polarization in our setup. Polarization controllers (PC) minimize the polarization transformation caused by the SMFs to the collected modes.

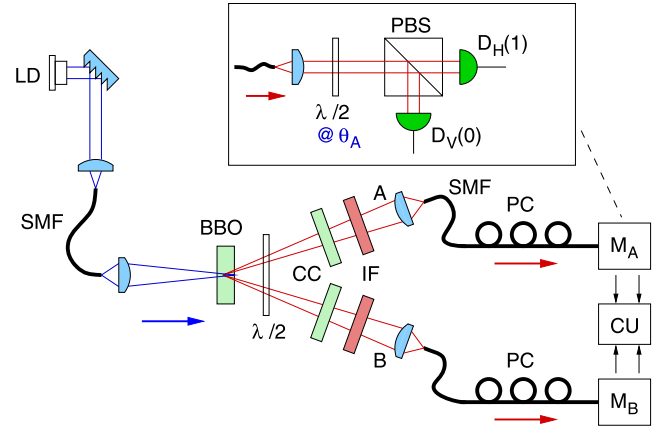

FIG. 3. Schematic of the experimental setup. Polarization correlations of entangled-photon pairs are measured by the polarization analyzers M_A and M_B , each consisting of a half-wave plate ($\lambda/2$) followed by a polarization beam splitter (PBS). All photons are detected by avalanche photodiodes D_H and D_V and registered in a coincidence unit (CU).

One of the CC is tilted to adjust the phase between the two decay possibilities, obtaining an output state very close to the singlet polarization Bell state $|\psi\rangle = 1/\sqrt{2}(|H\rangle_A|V\rangle_B - |V\rangle_A|H\rangle_B)$.

In the polarization analyzers (inset of Fig. 3), photons from SPDC are projected onto the linear polarizations necessary for the Bell tests by $\lambda/2$ plates, set to half of the analyzing angles $\theta_{A(B)}$, and polarization beam splitters with extinction ratios of 1/2000 and 1/200 for transmitted and reflected arms. Photons are detected by avalanche photodiodes (APD), and corresponding detection events from the same pair are identified by a coincidence unit if they arrive within $\approx \pm 3$ ns of each other.

The quality of polarization entanglement is assessed in the traditional way via the polarization correlations in a basis complementary to the intrinsic H/V basis of the crystal. With interference filters (IF) of 5-nm bandwidth (FWHM) centered at 810 nm, we observe a visibility of $V_{45} = 98.68 \pm 0.20\%$ in the 45° linear polarization basis. In the natural H/V basis of the type-II down-conversion process, the visibility reaches $V_{HV} = 99.67 \pm 0.12\%$.

Nonperfect symmetry of the collection modes can lead to “colored” noise, i.e., photon pairs that show anticorrelation only in a specific measurement basis [21], reducing the quality of the state. In a previous experiment [13], we have already estimated the very high quality of the state generated by this source. The nonideal visibility is due to the nonperfect neutralization of the polarization rotation caused by the SM fibers. This affects the outcome of the violation observed, as we discuss more in detail later.

B. Measurement and postprocessing

In this proof of principle experiment, we did not aim for a loophole-free demonstration. Due to the limited efficiency of the APD detectors (efficiency, $\approx 50\%$; dark count rates, $\approx 100 \text{ s}^{-1}$) and the source geometry, we assume that the detected photons are a fair sample of the entire ensemble.

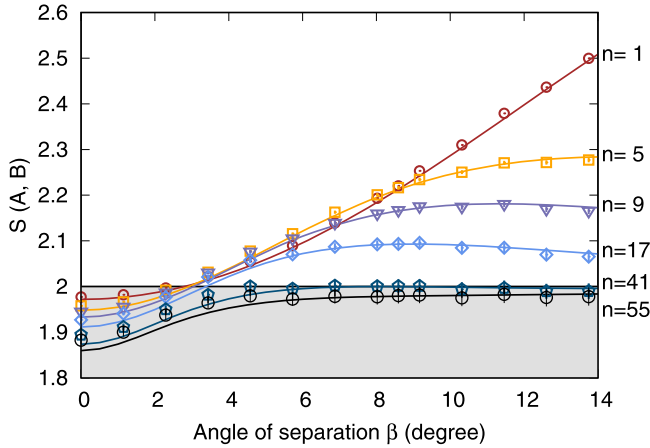

FIG. 4. Majority processing for different n applied to the data. The error bars are obtained from the bootstrapping procedure indicated in the text. The continuous lines are obtained numerically following Sec. II B, with $V = 0.9892$.

Similarly, even though Alice and Bob are not spacelike separated, we assume that no communication happens between measurements on both sides. Moreover, the basis choice is not random, as necessary for a Bell test. Instead, we set the basis and record the number of events in a fixed time. Based on our experience with the setup, we assume that the state generated by the source and all the other parameters of the experiment do not change significantly between experimental runs.

A single measurement run lasts 60 s, during which we record an average of 16×10^3 coincidences between detectors at Alice and Bob. A detection event at the transmitted output of each PBS is associated with 0 and at the reflected one is associated with 1. We discard any twofold coincidences between detectors belonging to the same party, corresponding to multiple pairs of photons generated within the coincidence time window. From the detected single rates, we calculate an expected rate for these events of $\approx 8.9 \times 10^{-6}$ 1/s.

To avoid a bias due to the asymmetries in detector efficiencies, we record coincidences not only in a basis (A_j, B_k) but also in three equivalent bases: $(A_j + 45^\circ, B_k)$, $(A_j, B_k + 45^\circ)$, and $(A_j + 45^\circ, B_k + 45^\circ)$. A rotation by 45° effectively swaps the roles of the transmitted and reflected detectors. Each party, when using such a rotated basis, needs to invert the measurement outcome. We repeat these measurement sets for a range of β and the corresponding four bases defined by Eq. (1).

To replicate the many-box scenario, we organize the sequence of results into clusters of size n for every set of measurement angles. For each cluster we calculate the majority (parity) binning using Eq. (6) [Eq. (9)]. Following the procedure in Eq. (5), we obtain a value of S_n for every n of interest. To evaluate the error associated with every S_n , the same procedure is repeated 1000 times, shuffling the order of the results every time before the clustering.

C. Discussion

The results of the measurement are reported in Fig. 4 for the majority vote and Fig. 5 for the parity binning. We estimate n_c in both cases by identifying the largest n that still shows a violation of inequality (5). For the case of majority

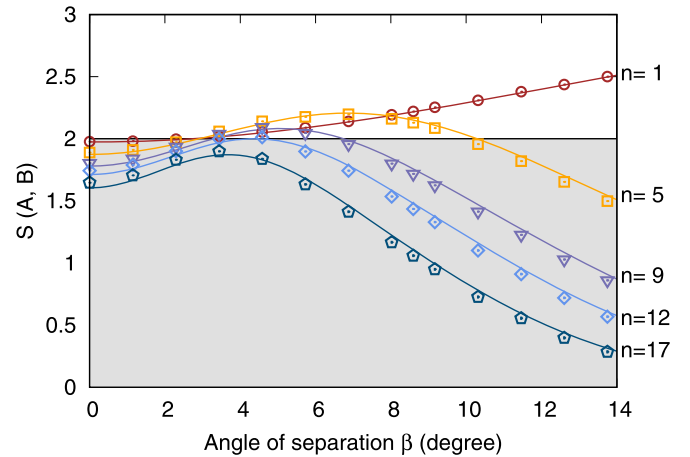

FIG. 5. Parity processing for different n applied to the data. The error bars are obtained from the bootstrapping procedure indicated in the text. The continuous lines are calculated using Eq. (11) with $V = 0.9871$.

vote, $n_c^{\text{maj}} = 41$. The continuous lines in Fig. 4 are obtained numerically, using as input a Werner state with $V = V_c^{\text{maj}} = 0.9892$ [cf. Eq. (7)]. Since the white noise of a Werner state corresponds to a worst-case scenario (any source with colored noise, with V being the minimal visibility over all choices of bases, will perform at least as well as the corresponding Werner state), the continuous lines are a lower bound on the observed violation. In Fig. 5 we observe that this is true indeed from small values of the angle β . Instead, for larger angles the experimental violation is smaller than the predicted lower bound. This is due to a rotation of the measurement basis due to the imperfect neutralization of the SM fibers. Due to the specific alignment procedure, this rotation affects the detected visibility more for larger angles, as indicated by the relatively low $V_{45} = 98.68 \pm 0.20\%$ in the 45° linear polarization basis. Reproducing the exact violation expected would require an extensive characterization of the rotation induced by the fibers that would not add to much to the present demonstration.

A similar procedure is applied to the parity binning. In this case, we find $n_c^{\text{parity}} = 12$. The continuous lines of Fig. 5 were obtained using Eq. (11) with $V_c^{\text{parity}} = 0.9871$ [cf. Eq. (13)]. Similar conclusions regarding the effect of the imperfect neutralization of the SM fibers can be drawn.

IV. CONCLUSION

We considered a many-pair scenario, where n identical entangled pairs are produced and measured collectively, and showed experimentally that a Bell inequality can be violated in this scenario. The maximal number of pairs for which a violation can be observed quantifies the high quality of the pair source. In our experiment we report a violation up to 41 pairs in the presence of majority voting and up to 12 pairs in the presence of parity binning. We also prove analytically that a violation can be observed in the presence of collective measurement for any number of pairs n and that this violation can remain significant for arbitrary n in the noiseless limit.

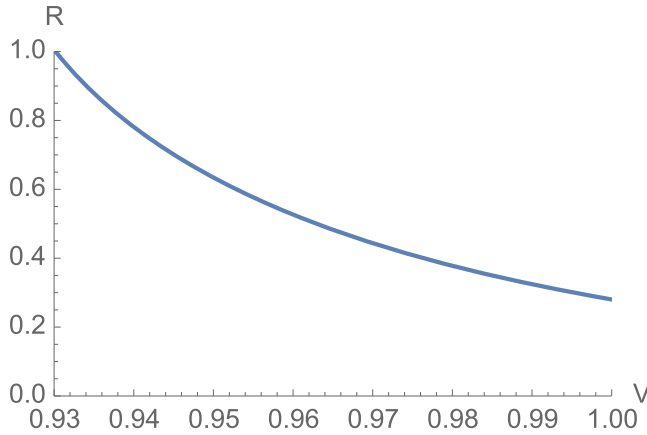

FIG. 6. Amount of Bell violation remaining in the parity case when considering $n = n_c/2$ pairs.

ACKNOWLEDGMENTS

We thank Enky Oudot for feedback and discussions. This research is supported by the Singapore Ministry of Education Academic Research Fund Tier 3 (Grant No. MOE2012-T3-1-009); by the National Research Foundation-Prime Minister's Office, and the Ministry of Education, Singapore, under the Research Centres of Excellence programme; by the Swiss National Science Foundation (SNSF), through the NCCR QSIT and Grant No. PP00P2-150579; and by the John Templeton Foundation under Grants No. 59342 ("Is the human eye able to see entanglement?") and No. 60607 ("Many-box locality as a physical principle").

APPENDIX: AMOUNT OF BELL VIOLATION WITH PARITY BINNING

In the main text we discuss the relation between the number of pairs at which a Bell violation can still be observed, for either majority or parity binning, and the quality of the source in terms of visibility V . The amount of Bell violation that is obtained in the many-pair scenario when using a majority binning is described in Ref. [12]. Here we analyze how the amount of Bell violation depends on the number of pairs in the

case of parity binning and compare it to the majority case. In particular, we show that it decreases more and more slowly as the visibility increases.

To see this, we consider the CHSH expression, Eq. (10), together with the choice of setting

$$\beta = \frac{\beta_0}{\sqrt{n}}, \quad \beta_0 = \frac{\sqrt{\ln(3)}}{2}. \quad (\text{A1})$$

As discussed in the main text, these settings give rise to a violation for a number of pairs smaller than

$$n_c(V) = \frac{1 - 3^{9/8}/4}{1 - V}. \quad (\text{A2})$$

We then estimate the sensitivity of the Bell violation to the number of pairs by computing the amount of violation that can still be observed when the number of pairs is half of the maximum possible number, i.e., $n = n_c/2$. For this, we define the ratio

$$R = \frac{S_n[V, n = n_c(V)/2] - 2}{S_n(V, n = 1) - 2}. \quad (\text{A3})$$

This quantity is represented in Fig. 6. Interestingly, only a fraction of the initial violation is lost independently of the visibility. The decrease in violation is thus linear in n .

Moreover, since the number of pairs considered here increases with the visibility, the Bell violation with parity binning becomes less and less sensitive to the number of pairs as the visibility increases. This contrasts with the case of majority voting, where the violation is upper-bounded by the case $V = 1$, which decays as $\sim 1/\sqrt{n}$.

Given this qualitative difference between the Bell violation provided by the majority and parity binnings, one should expect that the Bell violation provided by the parity binning would outperform the one provided by the majority procedure for a sufficiently large visibility. From Fig. 7, we see that this crossover occurs around $V = 0.994$.

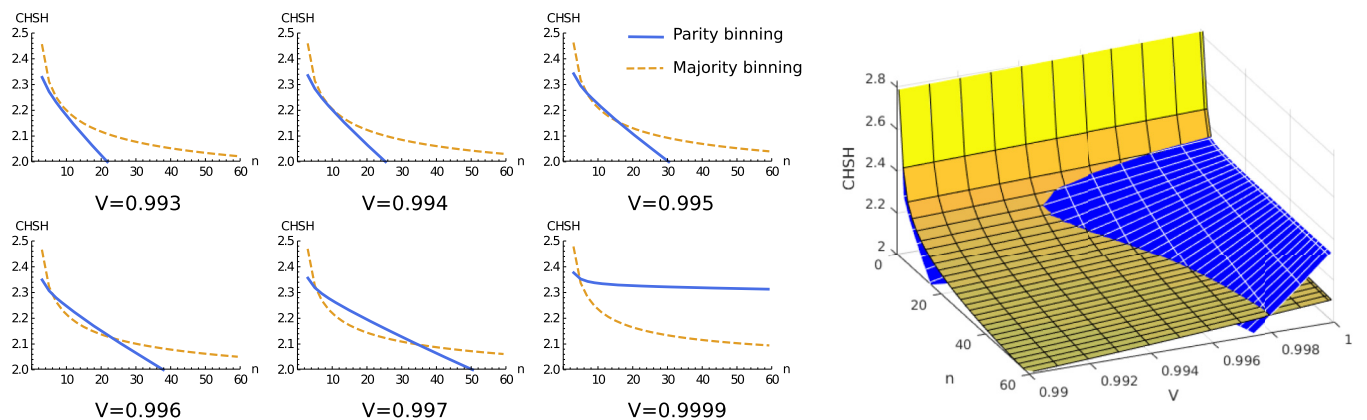

FIG. 7. CHSH violation achieved by the majority and parity binnings as a function of the source visibility V and number of pairs n . For $V \lesssim 0.994$, the largest Bell violation is achieved by the majority strategy. For $V \gtrsim 0.994$, the parity strategy provides a large violation for a range of n .

- [1] A. Aspect, John Bell and the second quantum revolution, Introduction to Ref. [2].
- [2] J. S. Bell, *Speakable and Unsayable in Quantum Mechanics*, 2nd ed. (Cambridge University Press, Cambridge, England, 2004).
- [3] L. Pezzè, A. Smerzi, M. K. Oberthaler, R. Schmied, and P. Treutlein, [arXiv:1609.01609](https://arxiv.org/abs/1609.01609).
- [4] N. Brunner, C. Branciard, and N. Gisin, *Phys. Rev. A* **78**, 052110 (2008).
- [5] P. Sekatski, N. Brunner, C. Branciard, N. Gisin, and C. Simon, *Phys. Rev. Lett.* **103**, 113601 (2009).
- [6] V. C. Vivoli, P. Sekatski, and N. Sangouard, *Optica* **3**, 473 (2016).
- [7] A. Dodel, A. Mayinda, E. Oudot, A. Martin, P. Sekatski, J.-D. Bancal, and N. Sangouard, *Quantum* **1**, 7 (2017).
- [8] R. Ramanathan, T. Paterek, A. Kay, P. Kurzyński, and D. Kaszlikowski, *Phys. Rev. Lett.* **107**, 060405 (2011).
- [9] J. Tura, R. Augusiak, A. B. Sainz, T. Vértesi, M. Lewenstein, and A. Acín, *Science* **344**, 1256 (2014).
- [10] R. Schmied, J.-D. Bancal, B. Allard, M. Fadel, V. Scarani, P. Treutlein, and N. Sangouard, *Science* **352**, 441 (2016).
- [11] M. Navascués and H. Wunderlich, *Proc. R. Soc. London, Ser. A* **466**, 881 (2009).
- [12] J.-D. Bancal, C. Branciard, N. Brunner, N. Gisin, S. Popescu, and C. Simon, *Phys. Rev. A* **78**, 062110 (2008).
- [13] H. S. Poh, S. K. Joshi, A. Cerè, A. Cabello, and C. Kurtsiefer, *Phys. Rev. Lett.* **115**, 180408 (2015).
- [14] B. G. Christensen, Y.-C. Liang, N. Brunner, N. Gisin, and P. G. Kwiat, *Phys. Rev. X* **5**, 041052 (2015).
- [15] X.-L. Wang, L.-K. Chen, W. Li, H.-L. Huang, C. Liu, C. Chen, Y.-H. Luo, Z.-E. Su, D. Wu, Z.-D. Li, H. Lu, Y. Hu, X. Jiang, C.-Z. Peng, L. Li, N.-L. Liu, Y.-A. Chen, C.-Y. Lu, and J.-W. Pan, *Phys. Rev. Lett.* **117**, 210502 (2016).
- [16] J.-D. Bancal, N. Gisin, and S. Pironio, *J. Phys. A: Math. Theor.* **43**, 385303 (2010).
- [17] <http://www.faacets.com>.
- [18] S. Pironio, *J. Math. Phys.* **46**, 062112 (2005).
- [19] P. G. Kwiat, K. Mattle, H. Weinfurter, A. Zeilinger, A. V. Sergienko, and Y. Shih, *Phys. Rev. Lett.* **75**, 4337 (1995).
- [20] C. Kurtsiefer, M. Oberparleiter, and H. Weinfurter, *Phys. Rev. A* **64**, 023802 (2001).
- [21] A. G. White, D. F. V. James, P. H. Eberhard, and P. G. Kwiat, *Phys. Rev. Lett.* **83**, 3103 (1999).