

Improvement on teleportation of continuous variables by photon subtraction via conditional measurement

T. Opatrný,^{1,2} G. Kurizki,¹ and D.-G. Welsch³

¹*Department of Chemical Physics, Weizmann Institute of Science, 761 00 Rehovot, Israel*

²*Department of Theoretical Physics, Palacký University, Svobody 26, 779 00 Olomouc, Czech Republic*

³*Theoretisch-Physikalisches Institut, Friedrich Schiller University, Max-Wien Platz 1, 07743 Jena, Germany*

(Received 5 August 1999; published 9 February 2000)

We show that the recently proposed scheme of teleportation of continuous variables [S.L. Braunstein and H.J. Kimble, Phys. Rev. Lett. **80**, 869 (1998)] can be improved by a conditional measurement of the entangled state shared by the sender and the recipient. The conditional measurement subtracts photons from the original entangled two-mode squeezed vacuum, by transmitting each mode through a low-reflectivity beam splitter and performing a joint photon-number measurement on the reflected beams. In this way the degree of entanglement of the shared state is increased and so is the fidelity of the teleported state.

PACS number(s): 03.67.-a, 03.65.Bz, 42.50.Dv

I. INTRODUCTION

The transfer of quantum information between distant nodes, as part of cryptographic or computing schemes, is hampered by the losses and particularly the decoherence incurred by the communication channel, as well as by the lack of sources that produce *perfectly* entangled states [1]. Various schemes based on unitary operations and measurements of redundant variables [2] or filtering [3] have been suggested to overcome these problems. A notable scheme aimed at improving the entanglement of qubits shared by distant nodes is quantum privacy amplification (QPA) [4]. We have recently suggested an alternative to the QPA, based on a conditional measurement (CM) which is designed to select an optimal subensemble of partly correlated qubits according to criteria that ensure significant improvement in the resulting entanglement (or fidelity), along with high success probability of the CM [5].

The present paper is motivated by a similar need for improving the recently studied scheme of teleportation of continuous variables [6,7] (see also Refs. [8–10]), in the spirit of the original Einstein-Podolsky-Rosen idea [11]. The prospects for realizing such teleportation are limited by the available squeezing of the entangled two-mode state. Perfect teleportation requires an infinitely squeezed vacuum, which is, of course, not available; the fidelity of the teleported state decreases with decreasing squeezing. Our objective here is to increase the fidelity by improving the entanglement properties of the shared state using conditional photon-number measurements. It has been shown that when a single-mode squeezed vacuum is transmitted through a beam splitter and a photon-number measurement is performed on the reflected beam, then a Schrödinger-cat-like state is generated [12]. Even though photons have been subtracted, the mean number of photons remaining in the transmitted state has increased. The newly generated states have often larger squeezing than the input squeezed vacuum.

Here we demonstrate by transmitting each mode of the two-mode squeezed vacuum through a low-reflectivity beam splitter and detecting photons in the reflected beams, the

transmitted modes are prepared in an entangled state which differs from the original one due to the photons subtracted by the measurement. Teleportation is performed if the two detectors simultaneously register photons. We show that such a CM can increase the degree of entanglement of the transmitted modes, as well as the fidelity of the teleported state.

This paper is organized as follows. In Sec. II we study the teleportation scheme in the Fock basis which is needed for our purposes. In Sec. III entanglement improvement by photon detection is studied. In Sec. IV the results are demonstrated for a particular teleported state. The conclusions are discussed in Sec. V.

II. TELEPORTATION IN THE FOCK BASIS

A. Recapitulation of results on continuous-variable teleportation

In order to teleport an unknown quantum state $\hat{\rho}_{\text{in}}$ of a single-mode optical field from one node to another one, the sender (Alice) and the recipient (Bob) must share a common two-mode entangled state. Let us first recall the original teleportation scheme for continuous variables as proposed in Ref. [6] (see Fig. 1 without the beam-splitters BS_1 and BS_2). The entangled state is a two-mode squeezed vacuum, which, in the Fock basis, can be written as

$$|\psi_E\rangle = \sqrt{1-q^2} \sum_{n=0}^{\infty} q^n |n\rangle_1 |n\rangle_2, \quad (1)$$

where the indices 1 and 2 refer to the two modes, and q , ($0 < q < 1$), is a parameter quantifying the strength of squeezing. The first mode is mixed, on a 50%-50% beam splitter BS_0 , with the input mode prepared in a state $\hat{\rho}_{\text{in}}$ Alice wishes to teleport. Homodyne detection is performed on the two output modes of the beam-splitter BS_0 (using the local oscillators LO_0 and LO_1) in order to measure the conjugate quadrature components \hat{x}_0 and \hat{p}_1 . By sending classical information, Alice communicates the measured values X_0 and P_1 to Bob, who uses the value $\sqrt{2}(X_0 + iP_1)$ as a displacement parameter for shifting the quantum state of the

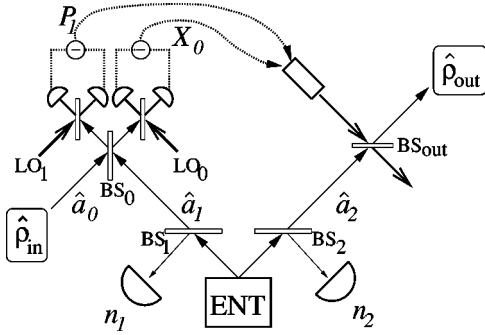

FIG. 1. Teleportation scheme: An input state $\hat{\rho}_{in}$ is destroyed by measurement and it appears, with certain fidelity, at a distant node as $\hat{\rho}_{out}$. The essential means is the entangled state created as a two-mode squeezed vacuum in the box ENT. The degree of entanglement is improved by CM of the numbers of photons n_1 and n_2 reflected at the beam-splitters BS_1 and BS_2 . After mixing the input mode prepared in the state $\hat{\rho}_{in}$ with mode 1 of the entangled state, the quadrature components \hat{x}_0 and \hat{p}_1 are measured and their values X_0 and P_1 are communicated by Alice to Bob via classical channels (dotted lines). Using these values as displacement parameters for shifting the quantum state of mode 2 on the beam-splitter BS_{out} , Bob creates the output state $\hat{\rho}_{out}$ which imitates $\hat{\rho}_{in}$.

second mode of the entangled state. The resulting quantum state $\hat{\rho}_{out}$ then imitates $\hat{\rho}_{in}$. The two states become identical, $\hat{\rho}_{out} \rightarrow \hat{\rho}_{in}$, in the limit of infinite squeezing, $q \rightarrow 1$.

We restrict ourselves, for the sake of simplicity, to pure states and describe the transformations in the \hat{x}_j quadrature-component representation [$\hat{x}_j = 2^{-1/2}(\hat{a}_j + \hat{a}_j^\dagger)$, $\hat{p}_j = -2^{-1/2}i(\hat{a}_j - \hat{a}_j^\dagger)$, $j=0,1,2$]. Let the input-state wave function be $\psi_0(x_0) \equiv \psi_{in}(x_0)$ and the entangled state have the wave function $\psi_E(x_1, x_2)$, so that the initial overall wave function is

$$\psi_I(x_0, x_1, x_2) = \psi_0(x_0)\psi_E(x_1, x_2). \quad (2)$$

We consider the scheme in Fig. 1 without the beam-splitters BS_1 and BS_2 . Assuming the beam-splitter BS_0 mixes the quadratures as

$$\begin{aligned} \hat{x}_0 &\rightarrow 2^{-1/2}(\hat{x}_1 + \hat{x}_0), \\ \hat{x}_1 &\rightarrow 2^{-1/2}(\hat{x}_1 - \hat{x}_0), \end{aligned} \quad (3)$$

the transformed wave function is

$$\psi_{II}(x_0, x_1, x_2) = \psi_0\left(\frac{x_1 + x_0}{\sqrt{2}}\right)\psi_E\left(\frac{x_1 - x_0}{\sqrt{2}}, x_2\right). \quad (4)$$

Upon measuring the quadratures \hat{x}_0 and \hat{p}_1 , in order to obtain the values X_0 and P_1 , the (unnormalized) wave function of mode 2 reads

$$\begin{aligned} \psi_{X_0, P_1}(x_2) &= (2\pi)^{-1/2} \int dx_1 \\ &\times e^{-iP_1 x_1} \psi_0\left(\frac{x_1 + X_0}{\sqrt{2}}\right) \psi_E\left(\frac{x_1 - X_0}{\sqrt{2}}, x_2\right). \end{aligned} \quad (5)$$

The probability density of measuring the values X_0 and P_1 is given by

$$\mathcal{P}(X_0, P_1) = \int dx_2 |\psi_{X_0, P_1}(x_2)|^2. \quad (6)$$

Using the measured values X_0 and P_1 to realize a displacement transformation on mode 2,

$$\begin{aligned} \hat{x}_2 &\rightarrow \hat{x}_2 - \sqrt{2}X_0, \\ \hat{p}_2 &\rightarrow \hat{p}_2 + \sqrt{2}P_1, \end{aligned} \quad (7)$$

the resulting (unnormalized) wave function of the mode is found to be

$$\begin{aligned} \psi_{out}(x_2) &= (2\pi)^{-1/2} \int dx_1 \\ &\times e^{iP_1(\sqrt{2}x_2 - x_1)} \psi_0\left(\frac{x_1 + X_0}{\sqrt{2}}\right) \\ &\times \psi_E\left(\frac{x_1 - X_0}{\sqrt{2}}, x_2 - \sqrt{2}X_0\right). \end{aligned} \quad (8)$$

An infinitely squeezed two-mode vacuum, $q \rightarrow 1$ in Eq. (1), can be described, apart from normalization, by the Dirac δ function,

$$\psi_E(x_1, x_2) \rightarrow \delta(x_1 - x_2). \quad (9)$$

It can easily be checked that Eq. (8) then reduces to

$$\psi_{out}(x_2) \rightarrow \psi_0(x_2), \quad (10)$$

i.e., the input quantum state is perfectly teleported. The open question is how to improve the fidelity of teleportation when, as in practice, $\psi_E(x_1, x_2)$ is not infinitely squeezed.

B. Transformation to the Fock basis

For the following it will be convenient to change over to the Fock basis. Let us express the input-state wave function in the form of

$$\psi_0(x_0) = \sum_n a_n^{(0)} \varphi_n(x_0), \quad (11)$$

with $\varphi_n(x_0)$ being the harmonic oscillator energy eigenfunctions

$$\varphi_n(x_0) = (2^n n! \sqrt{\pi})^{-1/2} e^{-x_0^2/2} H_n(x_0), \quad (12)$$

$H_n(x_0)$ being the Hermite polynomial. Quite generally, let the entangled state $\psi_E(x_1, x_2)$ be given by

$$\psi_E(x_1, x_2) = \sum_{k,l} a_{k,l}^{(E)} \varphi_k(x_1) \varphi_l(x_2). \quad (13)$$

In order to find the coefficients $b_m(X_0, P_1)$ of the Fock state expansion of the (unnormalized) wave function of the teleported quantum state

$$\psi_{\text{out}}(x_2) = \sum_m b_m(X_0, P_1) \varphi_m(x_2), \quad (14)$$

we insert $\psi_{\text{out}}(x_2)$ from Eq. (8) into Eq. (14) and obtain

$$b_m(X_0, P_1) = \sum_n C_{m,n}(X_0, P_1) a_n, \quad (15)$$

where $C_{m,n}(X_0, P_1)$ is given by

$$C_{m,n}(X_0, P_1) = (2\pi)^{-1/2} \sum_{k,l} B_{m,k}(X_0, P_1) a_{k,l}^{(E)} D_{l,n}(X_0, P_1), \quad (16)$$

with

$$B_{m,k}(X_0, P_1) = \int dx_2 e^{i\sqrt{2}P_1x_2} \varphi_m(x_2) \varphi_k(x_2 - \sqrt{2}X_0) \quad (17)$$

and

$$D_{l,n}(X_0, P_1) = \int dx_1 e^{-iP_1x_1} \varphi_l\left(\frac{x_1 - X_0}{\sqrt{2}}\right) \varphi_n\left(\frac{x_1 + X_0}{\sqrt{2}}\right). \quad (18)$$

The integrals in Eqs. (17) and (18) can be expressed in a closed form yielding

$$B_{m,k}(X_0, P_1) = \sqrt{2^{k-m}} \sqrt{\frac{m!}{k!}} \left(-\frac{X_0 - iP_1}{\sqrt{2}}\right)^{k-m} \times \exp\left(-\frac{X_0^2 + P_1^2}{2}\right) L_m^{k-m}(X_0^2 + P_1^2) \quad (19)$$

for $k \geq m$, and

$$B_{k,m}(X_0, P_1) = (-1)^{k-m} B_{m,k}^*(X_0, P_1), \quad (20)$$

and

$$D_{l,n}(X_0, P_1) = \sqrt{2} B_{l,n}^*(X_0, P_1), \quad (21)$$

$L_m^\alpha(y)$ being the (associated) Laguerre polynomial.

C. Probability and fidelity

Using the expansion (14), the probability density of measuring X_0 and P_1 , Eq. (6), reads as

$$\mathcal{P}(X_0, P_1) = \sum_m |b_m(X_0, P_1)|^2. \quad (22)$$

The fidelity of teleportation is defined by the overlap of the input quantum state with the (normalized) output quantum state. From Eqs. (11), (14), and (22) it follows that

$$F(X_0, P_1) = \mathcal{P}^{-1}(X_0, P_1) \sum_n |a_n^* b_n(X_0, P_1)|^2. \quad (23)$$

So far we have considered the output state under the condition of a particular measurement outcome (X_0, P_1) . When we ignore the outcome and many teleportations take place, then the resulting output state behaves as a mixture with the (unnormalized) density-matrix elements

$$\varrho_{m,m'} = \int dX_0 \int dP_1 b_m^*(X_0, P_1) b_{m'}(X_0, P_1). \quad (24)$$

The *averaged fidelity* in the Fock basis is then given by

$$F = \int dX_0 \int dP_1 F(X_0, P_1) \mathcal{P}^{-1}(X_0, P_1) = \sum_{m,m'} a_m^* \varrho_{m,m'} a_{m'}. \quad (25)$$

III. IMPROVING ENTANGLEMENT BY CONDITIONAL PHOTON-NUMBER MEASUREMENT

A. Conditionally entangled state

Let us apply the CM concept to a two-mode squeezed vacuum and assume that each mode is transmitted through a low-reflectivity beam splitter (BS_{*j*} in Fig. 1, $j=1,2$) and the numbers of reflected photons n_j are detected. Each beam splitter BS_{*j*} is described by a transformation matrix

$$T_j = \begin{pmatrix} t_j & r_j \\ -r_j & t_j \end{pmatrix} \quad (26)$$

with real transmittance t_j and real reflectance r_j , for simplicity. These matrices act on the operators of the input modes. After detecting n_j photons in the reflected modes, the Fock states $|k_j\rangle$ transform as ($n_j \leq k_j$)

$$|k_j\rangle \rightarrow (-1)^{n_j} \sqrt{\binom{k_j}{n_j}} |r_j|^{n_j} |t_j|^{k_j - n_j} |k_j - n_j\rangle \quad (27)$$

(for details and more general beam-splitter transformations, see Refs. [12,13]).

The expansion coefficients $a_{k,l}^{(E)}$ of the entangled two-mode wave function (13) are then transformed into

$$a_{k,l}^{(E, \text{new})} = (-1)^{n_1 + n_2} \sqrt{\frac{(k+n_1)!(l+n_2)!}{k!!n_1!n_2!}} \times |r_1|^{n_1} |r_2|^{n_2} |t_1|^{k-n_1} |t_2|^{l-n_2} a_{k+n_1, l+n_2}^{(E, \text{old})}. \quad (28)$$

Note that in this form the wave function is not normalized. The sum of the squares of moduli of the coefficients $a_{k,l}^{(E,\text{new})}$ gives the probability of the measurement results n_1 and n_2 . When the original entangled state is the two-mode squeezed vacuum, Eq. (1), i.e.,

$$a_{k,l}^{(E,\text{old})} = \sqrt{1-q^2} q^k \delta_{k,l}, \quad (29)$$

then the expansion coefficients (28) of the new state read

$$a_{k,l}^{(E,\text{new})} = (-1)^{n_1+n_2} \frac{\sqrt{1-q^2} (k+n_1)!}{\sqrt{k!(k+n_1-n_2)! n_1! n_2!}} \times |r_1|^{n_1} |r_2|^{n_2} |t_1|^k |t_2|^{k+n_1-n_2} q^{k+n_1} \delta_{k+n_1, l+n_2}. \quad (30)$$

The most important property of this expression is that the polynomial increase with k can, for small values of k , overcome the exponential decrease $(q|t_1 t_2|)^k$ and thus increase the mean number of photons. This is especially the case when $|t_j|$ is close to unity, i.e., large transmittance of the beam splitters. The price for that is, however, a decrease in the probability of detecting the photons.

An interesting question is whether we can optimize the scheme by adding more beam splitters and observing joint detection of photons reflected by each of them (a cascade of CMs). Unfortunately, for the squeezed vacuum as initial entangled state, no improvement was achieved in this manner. For example, the state generated by simultaneous detection of one photon reflected by each of two beam splitters in a cascade can be achieved (with higher probability) using one beam splitter and detecting two photons simultaneously. Note however, that this comparison is not generally valid for an arbitrary initial state.

B. Entropy as measure of entanglement increase

The increase of the degree of entanglement of the shared state produced by the CM described above can be quantified by comparing it with the original degree of entanglement. Even though there is no unique definition of a measure of entanglement for *mixed* states, there is a consensus on defining the degree of entanglement E of a two-component system prepared in a *pure* state as the von Neumann entropy of a component. The calculation of the partial entropies of the state in Eq. (13) together with either Eq. (29) or (30) is simple as the traced states are diagonal in the Fock basis. We derive

$$E = - \frac{\sum_k |a_{k,k+n_1-n_2}^{(E,\text{new})}|^2 \log |a_{k,k+n_1-n_2}^{(E,\text{new})}|^2}{\sum_k |a_{k,k+n_1-n_2}^{(E,\text{new})}|^2} \quad (31)$$

($k+n_1-n_2 \geq 0$; note that the entropies of the two components are equal to each other). If the logarithm base is chosen to be equal to 2, then the entanglement is measured in bits (or e-bits).

In Fig. 2 we have shown the dependence of the degree of

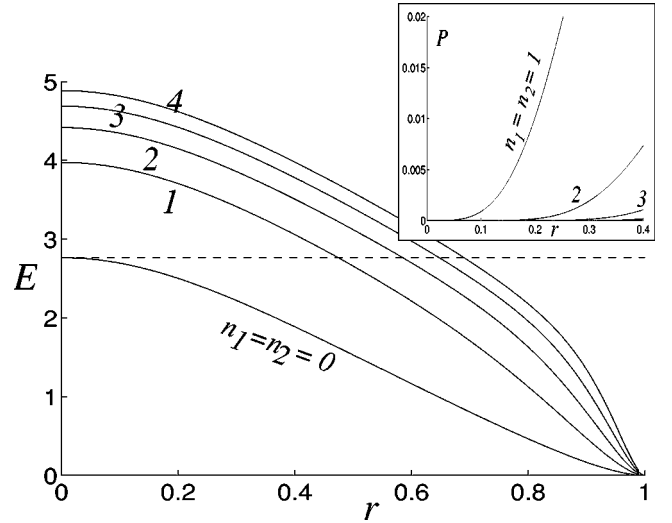

FIG. 2. Degree of entanglement (in bits) of the two-mode state in Eq. (13) together with Eq. (30) as a function of the reflectance $r=r_1=r_2$ of the beam splitters BS₁ and BS₂ in Fig. 1 for different numbers of detected photons, $n_1=n_2=0,1,2,3,4$. The dashed line indicates the degree of entanglement of the original squeezed vacuum, $q=0.8178$. Inset: probability of detecting $n_1=n_2=1,2,3$ photons as a function of the beam-splitter reflectance r .

entanglement and the detection probability on the beam-splitter reflectance for different numbers of detected photons, $n_1=n_2$. The original squeezed vacuum is chosen such that $q=0.8178$, which corresponds to the parameter $\text{arctanh } q = 1.15$ as in Ref. [6]. We see that after detecting one reflected photon in each channel the entanglement can be increased by more than 1 bit, and the effect increases with the number of detected photons. However, the probability of detecting more than one photon may be extremely small. Hence, one has to find a compromise between increasing the degree of entanglement and decreasing the success probability. One should also keep in mind that the partial von Neumann entropy as entanglement measure relates to the maximum information that can be gained about one component of a two-component system from a measurement on the other component. Therefore the partial entropy in Fig. 2 represents an upper limit for quantum communication possibilities rather than a direct measure of the quality of the teleportation scheme under consideration.

IV. RESULTS

We have performed computer simulations in order to test the method for different input states, especially for *Schrödinger cats*, which are popular “laboratory animals” in theoretical quantum optics (see, e.g., Ref. [6]). Figure 3 demonstrates teleportation of the state $|\Psi\rangle_{\text{in}} \sim (|\alpha\rangle - |-\alpha\rangle)$ with $\alpha = 1.5i$, which is chosen to be the same as in Ref. [6], for comparison.

The teleported quantum state that is obtained for a particular measurement of quadrature-component values X_0 and P_1 is shown in Fig. 4. The results in Figs. 4(a) and 4(b), respectively, correspond to the cases when the entangled state is a squeezed vacuum ($q=0.8178$) and a photon-

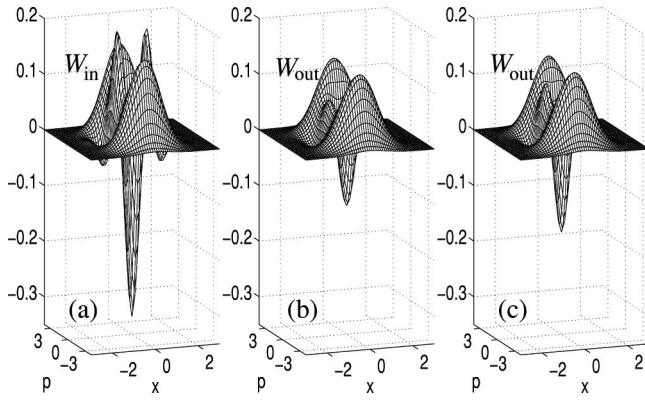

FIG. 3. (a) Wigner function of the quantum state to be teleported, $|\Psi\rangle_{\text{in}} \sim (|\alpha\rangle - |-\alpha\rangle)$, $\alpha = 1.5i$; (b) Wigner function of the teleported quantum state averaged over all measured quadrature-component values X_0 and P_1 , the entangled state being the squeezed vacuum with $q = 0.8178$; (c) same as in (b) but for the case when the entangled state is the photon-subtracted squeezed vacuum obtained by CM ($n_1 = n_2 = 1; r = 0.15$).

subtracted squeezed vacuum with $n_1 = n_2 = 1$, the probability of producing the state by CM being 0.39% ($r = 0.15$, cf. Fig. 2). The fidelity of the teleported quantum state, Eq. (23), is plotted in Fig. 5 as a function of the measured quadrature-component values X_0 and P_1 , and Fig. 6 shows the corresponding probability distribution, Eq. (22). We can see that not only the fidelity attains larger values for the improved entangled state, Fig. 5(b), but also the probability distribution is broader for that state, Fig. 6(b). The latter is very important. If the probability distribution is sharply peaked, then Alice actually gains more information about the state, so that there is less quantum information to be communicated to Bob. (Note the extreme case when the “entangled” state is

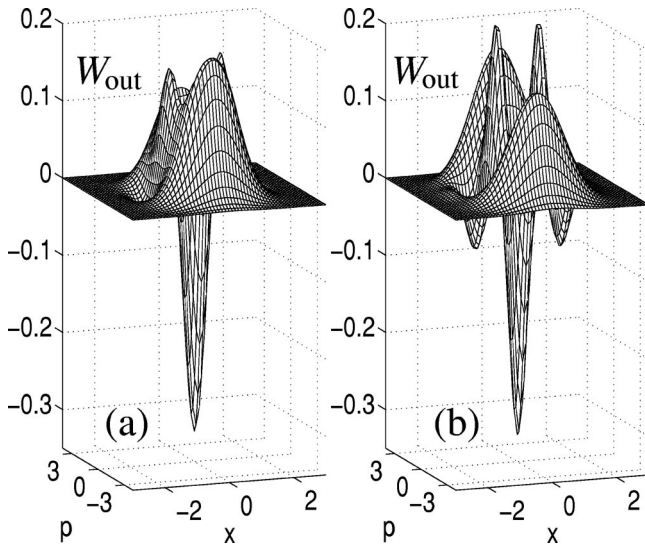

FIG. 4. (a) Wigner function of the teleported quantum state for $X_0 = 0.1$ and $P_1 = 0.2$ and the input state shown in Fig. 3(a) in the case when the entangled state is a squeezed vacuum with $q = 0.8178$; (b) same as in (a) but for the case when the entangled state is the photon-subtracted squeezed vacuum obtained by CM ($n_1 = n_2 = 1; r = 0.15$).

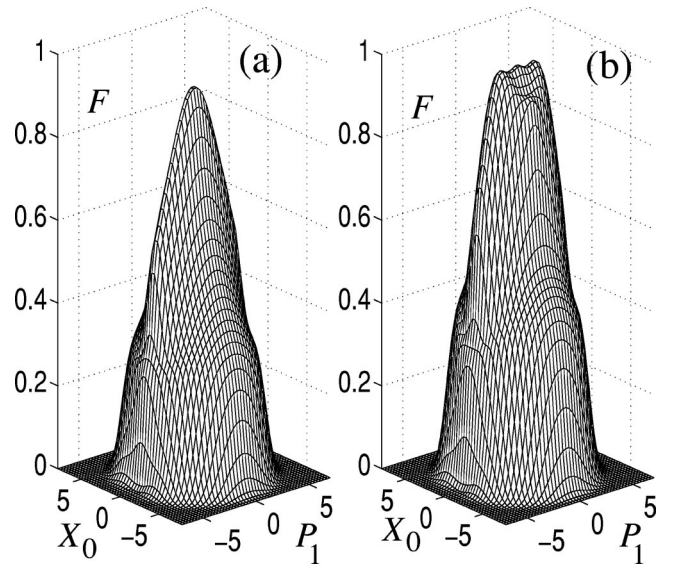

FIG. 5. Fidelity of the teleported quantum state in dependence on the measured quadrature-component values X_0 and P_1 for the input state shown in Fig. 3(a); (a) the entangled state is a squeezed vacuum ($q = 0.8178$); (b) the entangled state is the photon-subtracted squeezed vacuum obtained by CM ($n_1 = n_2 = 1; r = 0.15$).

simply the vacuum. Then Alice measures just the Q function of the state to be “teleported.” The probability distribution of the measured quantities thus carries the full information about the state.)

Upon averaging the fidelity $F(X_0, P_0)$ over the probability distribution of the measured quadrature-component values X_0 and P_1 , we get the averaged fidelity F , Eq. (25), which, for the case in our example, attains the value F

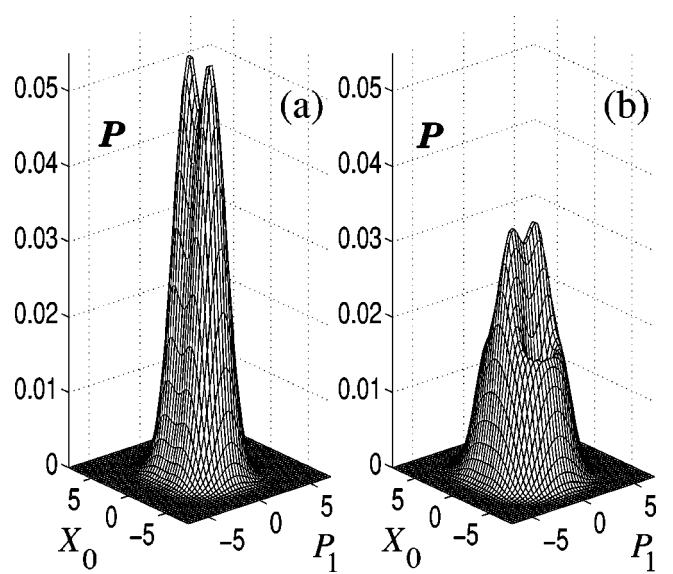

FIG. 6. Probability density of measuring the quadrature-component values X_0 and P_1 , Eq. (22), for the input state shown in Fig. 3(a); (a) the entangled state is a squeezed vacuum ($q = 0.8178$); (b) the entangled state is the photon-subtracted squeezed vacuum obtained by CM ($n_1 = n_2 = 1; r = 0.15$).

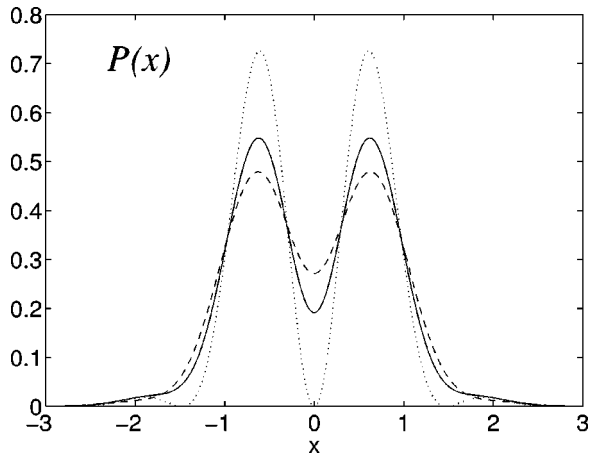

FIG. 7. Probability distribution of measuring the x quadrature in the teleported quantum state for the input state shown in Fig. 3(a); dotted line, input state; dashed line, teleported state if the entangled state is a squeezed vacuum ($q=0.8178$); solid line, teleported state if the entangled state is the photon-subtracted squeezed vacuum obtained by CM ($n_1=n_2=1; r=0.15$).

$=0.6463$ for the squeezed vacuum and $F=0.7444$ for the photon-subtracted squeezed vacuum, which is a significant increase. The Wigner function of the averaged teleported quantum state is plotted in Fig. 3. Again, we see that the state in Fig. 3(c), which is teleported by means of the improved entangled state, is closer to the original state in Fig. 3(a).

The quality of transmission of the interference fringes of the Schrödinger cat state can be seen from Fig. 7, in which the x quadrature distribution of the teleported quantum state is plotted. Whereas the input state shows perfect interference fringes in the x quadrature, the teleported states have the fringes smeared and their visibility decreased. In the example under study, the fringe visibility of the teleported state is 26.6% for the squeezed vacuum and 48.2% for the photon-subtracted squeezed vacuum obtained by CM.

V. DISCUSSION

Our results show that conditional photon-number measurement can significantly improve the fidelity of teleportation of continuous variables. With regard to experimental implementation, highly efficient single-photon counting is required. Even though such counting is at present not as efficient as intensity-proportional photodetection, progress has been very fast (as illustrated by the 88% efficiency achieved recently [14]). Therefore the prospects for the realization of the scheme appear to be good.

We note that the approach to purification studied in Ref. [15] for continuous variables—an approach analogous to that for spin variables in Refs. [1,2,4]—does not apply to Gaussian entangled states (i.e., states whose Wigner functions are Gaussians). To see this, we recall that the approach uses beam-splitter transformations in combination with quadrature-component measurements. The beam-splitter transformations can be represented by rotations in multimode phase space, and each quadrature measurement corresponds to a partial integration over a two-dimensional subspace. Hence, when the original state is Gaussian, then rotations and projections of the state ellipsoid onto lower dimensional ellipsoids must be performed, and it is clear that by this procedure we can never get a narrower ellipsoid (which would correspond to a more strongly entangled state) than the original one. Based on different arguments, the same conclusion is drawn in Ref. [15] and therefore attention is there restricted to non-Gaussian entangled states. Alternative approaches, such as the present one, circumvent this restriction.

The present scheme can also be extended to other types of conditional measurements. For example, combining (at the beam-splitters BS_1 and BS_2 in Fig. 1) the modes of the entangled two-mode squeezed vacuum with modes prepared in photon-number states, zero-photon measurement on the reflected beams then prepares a photon-added conditional state. Whereas the nonclassical features of a single-mode squeezed vacuum can be strongly influenced in this way [13,16], we have not found a substantial improvement of the degree of entanglement of the two-mode-squeezed vacuum.

We have considered here the case when Alice does not know the quantum state she wishes to teleport. Of course, the quantum communication scheme can also be applied to other situations, e.g., in quantum cryptography or state preparation in a distant place, where Alice can know the state. In particular, Alice can take advantage of her knowledge of the dependence of the teleportation fidelity on the measured quadrature-component values in Fig. 5 and communicate only the results of measurement which guarantee high fidelity. In that case, the teleportation can be regarded as being conditioned not only by the measured photon numbers in the entangled-state preparation but also by the measured quadrature-component values. This together with the possibility of optimization of probability versus fidelity suggests that there is a rich area of possible exploration of the scheme.

ACKNOWLEDGMENTS

This work was supported by EU (TMR), ISF, Minerva grants, and the Deutsche Forschungsgemeinschaft.

- [1] C. H. Bennett, D. P. DiVincenzo, J. A. Smolin, and W. K. Wootters, *Phys. Rev. A* **54**, 3824 (1996).
- [2] C. H. Bennett, G. Brassard, S. Popescu, B. Schumacher, J. A. Smolin, and W. K. Wootters, *Phys. Rev. Lett.* **76**, 722 (1996).
- [3] M. Horodecki, P. Horodecki, and R. Horodecki, *Phys. Rev. Lett.* **78**, 574 (1997).

- [4] D. Deutsch, A. Ekert, R. Jozsa, C. Macchiavello, S. Popescu, and A. Sanpera, *Phys. Rev. Lett.* **77**, 2818 (1996).
- [5] T. OpatrŇy and G. Kurizki, *Phys. Rev. A* **60**, 167 (1999).
- [6] S. L. Braunstein and H. J. Kimble, *Phys. Rev. Lett.* **80**, 869 (1998).
- [7] A. Furusawa, J. L. Sørensen, S. L. Braunstein, C. A. Fuchs, H.

- J. Kimble, and E. S. Polzik, *Science* **282**, 706 (1998).
- [8] T. C. Ralph and P. K. Lam, *Phys. Rev. Lett.* **81**, 5668 (1998).
- [9] P. van Loock, S. L. Braunstein, and H. J. Kimble, e-print quant-ph/9902030.
- [10] G. J. Milburn and S. L. Braunstein, e-print quant-ph/9812018.
- [11] A. Einstein, B. Podolsky, and N. Rosen, *Phys. Rev.* **47**, 777 (1935).
- [12] M. Dakna, T. Anhut, T. Opatrný, L. Knöll, and D.-G. Welsch, *Phys. Rev. A* **55**, 3184 (1997).
- [13] M. Dakna, L. Knöll, and D.-G. Welsch, *Eur. Phys. J. D* **3**, 295 (1998).
- [14] S. Takeuchi, J. Kim, Y. Yamamoto, and H. H. Hogue, *Appl. Phys. Lett.* **74**, 1063 (1999).
- [15] S. Parker, S. Bose, and M. B. Plenio, e-print quant-ph/9906098.
- [16] M. Dakna, L. Knöll, and D.-G. Welsch, *Opt. Commun.* **145**, 309 (1998).