

INTERNAL RELATIONS IN AUDION-TYPE RADIO RECEIVERS.

BY RALPH BOWN.

THE audion-type radio detector consists of an evacuated glass bulb containing three electrodes; an electron-emitting hot cathode, which is commonly a tungsten filament, a cold metal plate placed near the cathode and held at a considerable positive potential with respect to it, and, interposed between these two, a grid or lattice of metal wires. The device is widely used and is well known as a detector in radio-telegraphy or as an amplifier of electrical impulses such as telephonic currents. It has been made in various forms and modifications by various workers, but without radical departure from the fundamental principle of the control of the thermionic current between two electrodes by means of the relative electrical potential of a third electrode. A fairly extensive literature¹ has been built up about the use of the audion type detector. Many of its peculiarities and operating features have been fully explained, but at the same time many of them have not been satisfactorily treated and not a few of them have been disposed of with the mere statement that they were due to the irregularities of the conduction of electricity through gases. The writer has devoted considerable attention to the effect of the gas in the ordinary audion type bulb and the object of the present paper is to give some of his results and conclusions. The discussion is focused particularly upon the interior of the bulb itself and the relations therein as distinct from the circuits in which the bulb is used, and upon the explanation of such peculiarities and eccentricities of the apparatus as may be traced back to the gas.

THEORY OF OPERATION.

In the ordinary wireless receiving outfit the circuit used is the one diagrammed in Fig. 1. It consists of three parts which have a common point at the negative end of the filament. These three circuits are: the

¹ DeForest, Lond. Electr., Vol. 72, p. 285, 1913, or Proc. Inst. Radio Eng., Vol. 2, p. 15, 1914. Reisz, Eleck. Tech. Zeit., Vol. 34, p. 1359, 1913, or Lond. Electr. Vol. 72, p. 726, 1913. Armstrong, Proc. Inst. Radio Eng., Vol. 3, p. 215, 1915, or Lond. Electr., Vol. 74, p. 798, 1916. Langmuir, Proc. Inst. Radio Eng., Vol. 3, p. 261, 1915, or General Electric Review, Vol. 18, p. 327, 1915.

filament with its heating battery and regulating rheostat; the plate, in series with the telephone receivers and the high tension adjustable battery; and the grid in series with its blocking condenser, *B.C.*, and the tuned oscillating circuit coupled to the antenna.

It has been found that the current of electrons from the hot filament to the plate depends upon the electrostatic potential of the grid in the manner shown by the curve in Fig. 1, and on this as a basis the operation of the device as a detector of high frequency oscillations has been commonly explained in the following manner: Due to the unilateral conductivity between the hot cathode and a cold electrode, the incoming oscillations are rectified between the grid and the filament and accumulate a negative charge on the grid and the connected plate of the blocking con-

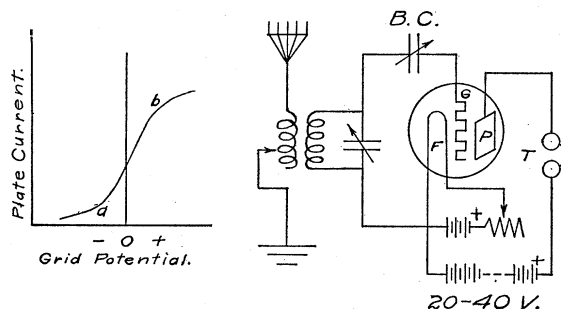

Fig. 1.

Ordinary audion radio receiver.

F, filament. *G*, grid. *P*, plate. *B.C.*, blocking condenser. *T*, telephone receivers. *a*, *b*, operating curve.

denser. This decrease of the grid potential causes a corresponding decrease in the plate current, as indicated by the curve. The dying out of the oscillations allows the charge on the grid to leak off through the gas and the plate current reassumes its normal value. This function takes place for every wave train of the damped oscillations and when they occur in rapid sequence, as from a musical spark transmitter, a musical tone is produced in the telephone receivers by the changes in the plate current. Oftentimes the blocking condenser is left out of the circuit and a metallic connection exists between the grid and filament through the tuning coil. A different explanation has been used for such a connection. The grid potential is supposed to be maintained normally at a point on one of the bends of the curve such as at (*a*) or (*b*). Then as the grid potential alternates back and forth about this mean value, due to the incoming signals, the resulting plate current changes, on account of the asymmetry of the curve, are not symmetrically alternating about the normal value but have a

direct current component. Thus each wave train produces a unidirectional impulse in the telephones and the rapid succession of them gives the musical tone.

The adjustment of a bulb to procure the best results requires careful manipulation of the plate voltage and the filament current. Placing it in a regular receiving circuit, setting for the best operating condition on actual signals, and then transferring it to a test circuit where the adjustments could be duplicated and the data for the characteristic curves taken, proved to be unsatisfactory, because the adjustment is quite delicate and can only be correctly made when listening to the signals in the telephones. Therefore, an artificial circuit was built up as in Fig. 2. The filament and plate circuits, except for the addition of a voltmeter and ammeter, were identical with those in Fig. 1. In the grid circuit were placed, an ammeter, a potentiometer with switches to cut it in and out and a voltmeter to measure the setting, a blocking condenser (B.C.) with a short-circuiting switch, and a tuned oscillating circuit, also with a short-circuiting switch, for receiving signals from the buzzer and automatic telegraph sender in the artificial antenna circuit to which it was coupled and tuned. With this arrangement a detector could be adjusted to the best operating condition on actual signals either with the potentiometer cut out and the blocking condenser in or *vice versa*. Then, with the blocking condenser short-circuited, the potentiometer in and with the tuned circuit either receiving signals or cut out, just as was desired, the curves of grid potential against plate current and grid current could be observed. After taking the data, or during the process, it was merely necessary to throw the switches in order to check back and see that the adjustment as a detector had not changed. Curves for any other condition than that of best operation could also be taken with equal ease.

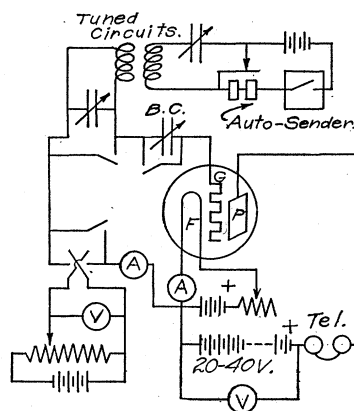

Fig. 2.
 Test circuit.

The observations made are here represented partly by the accompanying curves and partly by statements in the text. They show the truth of the ordinary explanation of the audion working with a blocking condenser, throw some new light on the operation without the blocking condenser and furnish a basis for a theory of the internal relations in the bulb.

In the curves (Figs. 3, 4, 5, 6, 8), values of current above the zero current line mean negative electrons flowing to the cold electrode in question (*i. e.*, grid or plate) while values below the zero current line mean positive ions flowing to the cold electrode. The potential of the common point at the negative end of the filament is assumed as zero and the grid and the plate voltages are measured from it. The upper curves show the relation between grid potential and grid current and the lower curves show the simultaneous relation between grid potential and plate current. The voltages labeled on the curves refer to the plate. The real key to understanding the action of the audion lies not in the plate current curve but in the grid current curve and upon it the following explanations are largely based. The characteristic relations for two points of best adjustment as a detector are given in Fig. 3. That Fig. 3 is really a typical

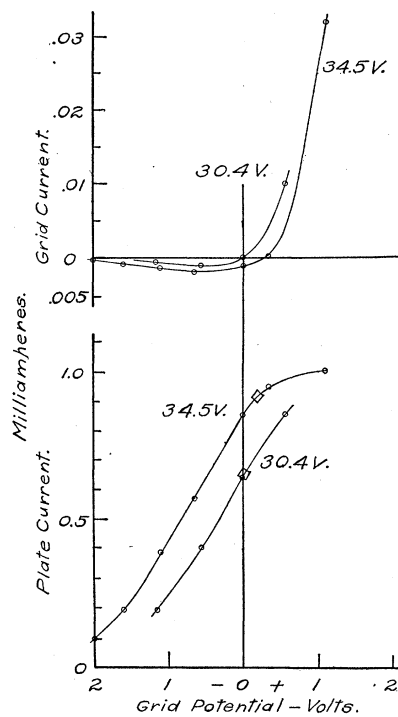

Fig. 3.

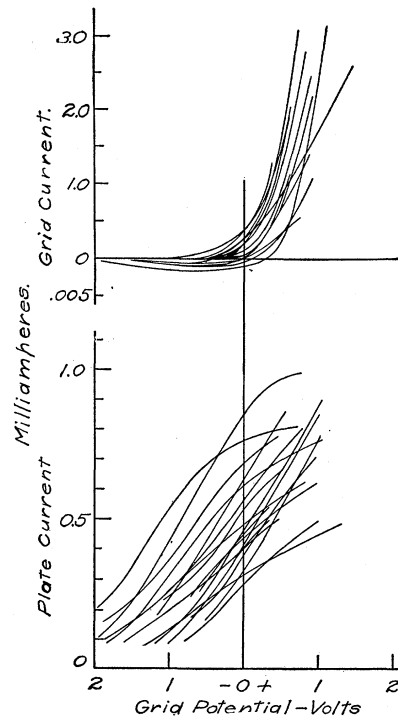

Fig. 4.

case and that remarks made about it will apply to any similar detector may be seen by comparison with Fig. 4 which is a composite plot of comparable curves taken at random from a large number of audion type detectors of many different makes and shapes, including some experi-

mental bulbs of exceptional dimensions. Although the curves of Fig. 4 do not lie so close together that they may be said to superimpose, nevertheless, they are all of similar shape and character and in the light of remarks to follow will be seen to be governed by the same considerations.

It is apparent from Fig. 3 that positive ions exist in the bulb and that some of them are drawn to the grid, since the grid current crosses and goes below the zero current line. When a blocking condenser is inserted in the grid circuit no current can flow through it and so the grid must assume the potential at which the grid current becomes zero. The squares on the plate current curves indicate the measured values when the blocking condenser was in, and, on comparison with the grid current at the same ordinates, will be seen to substantiate the above statement. When a group of voltage oscillations is impressed on the grid, the negative ions collected by it on the positive half waves far outnumber the positive ions collected on the negative half waves. The grid acquires a preponderance of negative charges, assumes a more negative potential, backing off to the left on its curve and at the same time causing a reduction in the plate current. When the group of oscillations has passed, the grid is left at a potential where it is drawing a positive charge, which neutralizes the former condition. The grid potential moves back to the position of zero current, thereby allowing the plate current to increase to normal. The curves show in detail just how this action takes place.

The author has never been able to make an audion work at all well on the lower bend of the plate current curve and so has eliminated this from consideration. It was found, however, that good operation without the blocking condenser could be had not only on the upper bend but in the straight portion of the curve as well. In fact, in many cases a detector would operate equally well on the straight part of the curve irrespective of whether or not a blocking condenser was used and occasionally better without. The explanation of these conditions required something more than reference to the curvature of the plate current curve. The required factor proved to be the curvature of the grid current curve. Take for example the 30.4 volt curve in Fig. 3 or the 39 volt curve in Fig. 5. With no blocking condenser the grid will normally be at zero potential. Now if an oscillation be impressed on it, a large grid current tends to flow on the positive half waves of grid voltage and a much smaller current on the negative half waves. The voltage of the positive half waves is largely used up in resistance and reactance drop trying to force a large current through the tuning coil, while the negative half waves, being almost unburdened with current changes, are free to vary the potential of the grid. The integrated

effect is to cause the average-grid potential during a group of oscillations to be negative and the plate current to undergo a reduction of the same sort as occurs when the blocking condenser is used. The best operation will be realized when the grid potential is normally at a point of most advantageous curvature in the grid current curve and a battery in the grid circuit may be of assistance in obtaining this condition. The point of most advantageous curvature is, roughly, the point where the ratio

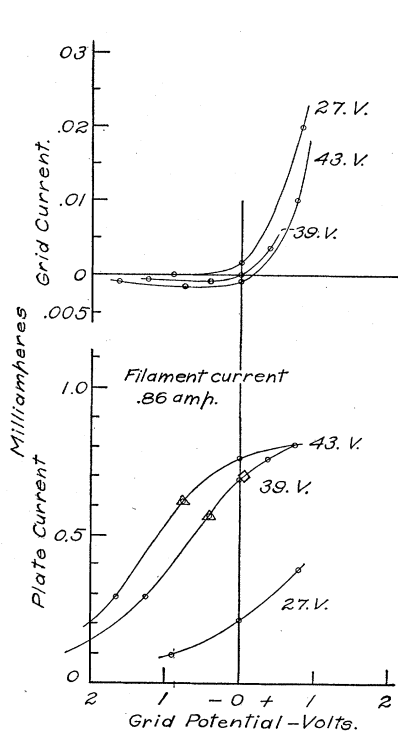

Fig. 5.

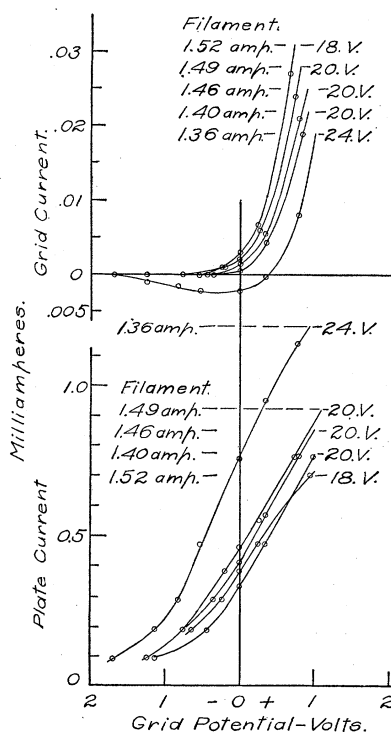

Fig. 6.

of the current changes produced by equal and opposite potential changes, is a maximum. This is not necessarily the place where the second derivative of the curve is a maximum, nor yet is it exactly the same point for signals of different intensities, because the potential changes produced by signals are finite and variable. Furthermore, the resistance and inductance of the tuning coil and the amount of energy the circuit receives from an incoming signal are factors which affect the relative voltage and current variations. On account of this complexity in the relations neither judgment by inspection nor mathematical analysis of the curves is very helpful in determining just where the best point lies. The tests

indicate that it generally lies quite near the place where the grid current curve just starts to rise upward from the horizontal. Considering the curvature of the plate current curve at the upper bend as an explanation of the operation without a blocking condenser, it is true that a signal produces a reduction in the plate current of the same nature as, according to the above explanation, is produced by the action of the grid current and that the two effects act together for the same result. Two experimental facts lead to the conclusion that the bend in the plate current curve is a very minor factor. The first is that the operation is not dependent on this bend but may occur just as satisfactorily on the straight portions of the curve. The second is that the best point is found to be linked with the grid current bend in the manner explained above. For example, in Fig. 5 the triangular points are the ones of best operation without the blocking condenser. They occur just where the grid currents start to rise and are at the same time well below the knees of the plate current curves. When receiving loud signals it was very noticeable that the microammeter in the grid circuit received an impulse with each dot or dash, in the direction which showed a large momentary excess of negative ions flowing to the grid.

Knowing that in the average case the detector is working on the straight portion of the plate current curve and that, therefore, this will only be of importance as it may undergo slight changes of slope, we may now look at the shape of the grid current curve as affected by plate voltage and filament current. We will consider for the present only the facts, leaving the reasons for later discussion. From Fig. 5 it will be seen that an increase in the plate voltage at constant filament current has the general effect of shifting the grid current curve downward and to the right. The 20-volt curves (from another bulb) in Fig. 6 show that an increase of filament current at constant plate voltage has an opposite effect, the curve is raised and moved to the left. In order to locate the bend in the grid current curve at the proper position these two variables must be correspondingly adjusted. Since they work in opposite directions, an increase in one is partly compensated by an increase in the other and *vice versa*. Thus it is often observed that by raising both plate voltage and filament current several satisfactory adjustments can be found, although one of them will usually be most sensitive. The reasons for the behavior of the curves may be derived from the ionization phenomena occurring in the bulb.

ACTION OF THE GAS.

Langmuir¹ has shown that in the absence of any gas the current of electrons which flows from an electron-emitting cathode to a second elec-

¹Langmuir, *PHYS. REV.*, Sec. Ser., Vol. II., p. 450, 1913.

trode as anode is a function of the geometry of the system and the voltage between the electrodes and is independent of the rate of emission as long as the saturation current is not reached. He has given curves very similar in appearance to those of Fig. 7 to illustrate the phenomenon, which is

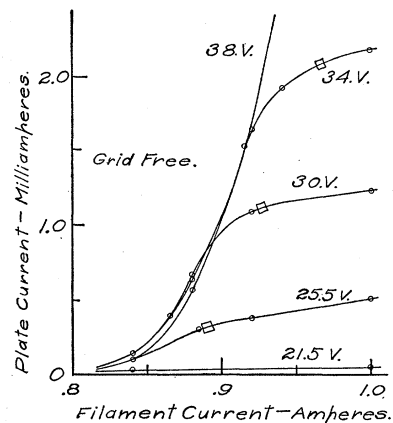

Fig. 7.

explained as being due to the "space charge." The explanation is briefly as follows: The emission from a filament is governed by its composition, its superficial area and its temperature, according to Richardson's well-known law.¹ As the filament temperature is raised from the point where emission begins, at first all the electrons are drawn to the anode and the current is saturated. But finally a certain equilibrium density of the negative charges in the space between the electrodes is reached which masks the positive charge on the anode to such an extent that the electric field

gradient at the surface of the cathode is reduced to zero or nearly so. The negative space charge thus prevents further increase of the anode current no matter how much the emission may be increased. Now the audion is dissimilar to the ideal two-electrode system of Langmuir in two respects; the electric field is greatly modified by the interposition of the grid member and there is the presence of ionizable gas.

Since the grid is always near zero potential, the electric field between it and the filament is of very low intensity and, on account of the drop of potential along the filament produced by the heating current, the field gradient out to the grid becomes increasingly negative toward the positive end of the filament. Assuming the absence of any gas, the plate would thus be restrained from attracting many electrons by the screening action of the grid, for even though the plate is able to extend its influence well down between the grid bars, the influence is so weak as to be neutralized by a very small space charge of electrons unless the grid is very coarse or very high plate voltages are used. It will now be shown how the introduction of gas and the consequent formation of positive ions tends, in a certain sense, to nullify the effect of the grid. Some of the ions may be formed near the filament by collision of positive ions with gas molecules or perhaps spontaneously due to the high temperature of the gas near the

¹ Richardson, *The Emission of Electricity from Hot Bodies*, Chapters I. and III.

hot surface, but the great majority of them are produced by collision of electrons with gas molecules in the region between the grid and the plate, for there the electrons attain the greatest speeds. Irrespective of where the positive ions come into being, they are drawn toward the grid as the place of lowest potential. Those outside the grid on being drawn toward it either strike it and are absorbed or shoot between the bars and bombard the filament, or, being deflected by collisions, join the number inside the grid which are more slowly drifting to it under the influence of the weaker field. There is then, diffusing about inside the grid, an intimate mixture of positive and negative ions, the presence of both kinds of ions greatly reducing any effect which may be due to the space charge of one of them. For this reason the number of electrons which the electric field of the plate can attract through the grid is greatly increased over the number which can be attracted when only negative ions are present and their space charge is fully effective. The grid and the positive ions have, then, for a steady state, partly offset each other, as is shown by the magnitude of the plate current and by the previously mentioned similarity of the curves in Fig. 7, for an audion, to the comparable curves when the grid and gas are lacking. However, since in the ordinary range the amount of ionization is practically invariant with regard to changes in the grid potential, variations in the potential of this member will still have their full effect in modifying the electric field and consequently the plate current. The characteristic curves of plate current and grid current against grid potential can now be accounted for.

Plate Current Curve.—The plate current varies, within limits, directly with the grid potential because the grid potential (other things remaining constant) determines the electric field inside the grid and, therefore, the number of electrons which are drawn out between the grid bars to the plate.

Grid Current Curve.—Since the grid is normally negative all along with respect to its adjacent filament, the electric field is opposed to its absorbing electrons and it takes on very few. The positive ions are, on the other hand, attracted to it all along its length, and, as the curves show, it gets the saturation current of them. Changing the grid potential from negative to positive causes part of the grid to begin attracting electrons and the large supply of them allows it to attract a great many. Thus the grid current curve has a small, nearly constant value below the zero line for negative grid potentials and rises sharply in the neighborhood of zero potential as the attraction of electrons begins. The location of the bend and the absolute values of the grid current ordinates are determined by the filament current and the plate potential, and also, as will be shown

later, by the shape of the electrodes and by the nature and pressure of the gas. Their influence is exercised through their effect on the body of ions between the electrodes. An equality always exists between the rates of supply and the rates of removal of both kinds of ions, but the equilibrium numbers of the ions present and the actual values of the rates will be dependent on the existing physical conditions as controlled by the factors mentioned. For low plate voltages very few positive ions are formed and the charges collected by the grid and forming the grid current may always consist of a preponderance of electrons (see Fig. 6). As the plate voltage is raised more positive ions are formed and contribute to the grid current, while the increased electric field intensity causes the electrons in the neighborhood of the grid to have a greater tendency to be drawn between the bars out to the plate and a lesser tendency to strike the grid, so that a larger positive potential on the grid is necessary to attract many of them. These two things taken together result in a shift of the grid current curve downward and to the right. Increase in the filament current produces an opposite effect for the reason that it raises the available supply of electrons, thereby increasing the tendency for them to strike the grid. At the same time it somewhat lowers the number of positive ions, because the increased number of electrons which come out from the filament and execute a limited, low velocity flight inside the grid and back to the filament, is a favorable condition for an increased rate of recombination.

Looking again at Fig. 7, it will be seen that the best operating point on the curves is, in every case, just above the knee, as indicated by the squares. This fact, taken in conjunction with the foregoing discussion, shows that the most sensitive point, the point where the most advantageous bend in the grid current curve occurs at the zero current value and where the optimum relation between the flow of the positive and negative ions to the grid is obtained, is identical with the point where the plate begins to be unable to draw any more electrons from behind the grid even if considerably more of them are supplied. For higher filament temperatures an excess of electrons is present and, although most of them return to the filament, still, some are forced on the grid even when it is at a negative potential, which means that the bend is smoothed out and also, perhaps raised above the zero grid current line. For lower temperatures insufficient electrons are present to supply the demand of the plate and the electric field near the grid is modified so that the grid cannot easily acquire electrons even when slightly positive. The positive ions form the principal part of the current and the bend occurs less sharply and perhaps below the zero current line. Thus, either above or below the

optimum temperature of the filament, conditions are less favorable to sensitiveness, particularly when the blocking condenser is employed. This shows why, in the ordinary use of the audion, the adjustment of the filament current is the final and most delicate one.

The values of plate voltage and filament current necessary for best adjustment are dependent on the nature and pressure of the gas and on the dimensions of the electrodes, since these things affect the amount of ionization and the shape of the electric field. Decreasing gas pressure in a bulb requires an increasing plate voltage to bring it up to the best condition. This is often noticed in a bulb which is used continuously for some time. The "clean up" of the gas lowers the pressure and the plate voltage must be raised from time to time until, finally, either the bulb must be discarded or the gas pressure restored by heating up the glass walls. The reason is that the decreased production of positive ions, due to a reduced number of gas molecules, must be compensated by the increase of ionization and the shift of the grid current curve which can be caused by a higher plate voltage. All of the writer's experiments have been carried on with the residual gas from the ordinary exhausting apparatus, in which case the optimum pressure was .005 to .010 mm. of mercury. This gas is no doubt made up principally of nitrogen and water vapor with a trace of mercury vapor, oil vapor, etc. Undoubtedly changes in the nature of the gas in a tube would have some effect on the characteristics of the operating curves since they would be accompanied by changes in the ionizing potentials. Although various gases and vapors, particularly mercury vapor,¹ have been tried in audion-type relays by different experimenters and with varying success, no data are available from consistent tests in which similar conditions of electrodes were maintained for the different gases. In a bulb which contains ionizable gas and which is used as a detector, considerable changes in the shape and size of the electrodes may be made without appreciable effect on the maximum sensitiveness, because the changes are largely neutralized by the necessary accompanying alterations in the plate voltage and the filament current. This is not true of amplifiers containing very little gas. Variations in the sensitiveness are often observed when a magnetic field is caused to act on the bulb. These variations are due to the effect of the field in shifting the paths of the electrons and thereby modifying the operating curves into more or less advantageous shapes, as the case may be. Bulbs in which the grid and plate but partly enclose the filament are most affected by a magnetic field.

An abnormal condition is encountered when the plate voltage is raised

¹ Reisz, loc. cit.

considerably above the ordinary value. A luminous discharge appears in the tube and is seen as a cloud, light blue in color, between the grid and plate and sometimes extending around the grid toward the negative end of the filament. It is caused by the active and thorough ionization of the gas by electron bombardment. The appearance of the blue glow is often presaged by a hissing in the telephone receivers similar to the hissing of an ordinary electric arc which is running at too high a current density. In bulbs where the filament is only partly screened by the grid and plate electrodes the glow may, at high voltages, fill the entire tube. With such raising of the plate voltage the characteristic curves of an audion undergo radical changes as shown typically in Fig. 8. The

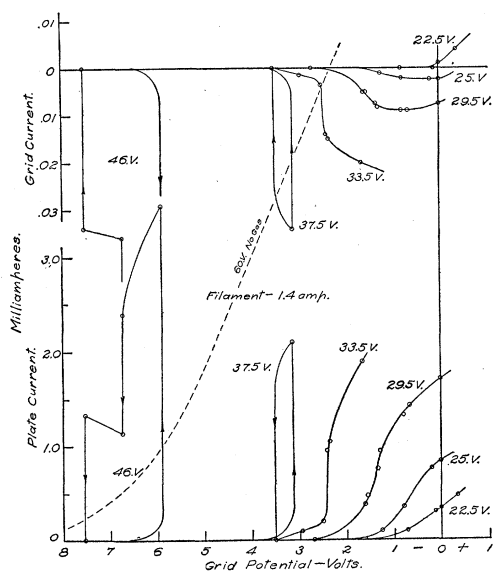

Fig. 8.

22.5-volt curves are the normal ones on which good detector action is realized either with or without the blocking condenser. On the 25-volt curves the bulb can be made to work fairly well without the blocking condenser. Between the 25-volt and 33.5-volt curves it is a very poor detector though fair as an amplifier, but above 33.5 volts it is practically useless as either. The successive curves occupy positions farther and farther to the left because the screening action of the grid is reduced by the increasing plate voltage. Not only does the number of positive ions drawn to the grid become larger as the plate voltage goes up but the shape of the grid-current curve, if inverted, shows a peculiar similarity to that of the plate-current curve. The two curves are partly interde-

pendent at this stage. An increase in the ionization modifies conditions around the grid, as has been previously explained, in such a way as to allow a larger plate current, which, in turn, causes more ionization and consequently still more plate current, so that the conditions tend toward instability on account of the "progressive ionization." The increasing effect of this phenomenon can be followed in Fig. 8 from the place where it is present but very slightly (25-volt curves) to the place where instability is reached and the changes are critical (37.5-volt curves). Blue glow makes its appearance in the tube at the same voltage at which the current becomes critical. In discussions of the audion it has occasionally been stated that the great sensitiveness of the device is due to this progressive ionization. The author has found no evidence of such a function in the ordinary range of plate voltages in which successful operation as a detector may be realized. Even good working as amplifier in the progressive ionization region is doubtful for in spite of the great steepness of the plate current curve, the grid current curve is also so steep that the power amplification is usually poor.

SUMMARY.

Experimental curves are shown from which the details of the operation of the audion as a detector in radio telegraphy are followed. A theory of the action of the gas in the bulb is presented which explains the curves and is in agreement with all the observations. Some of the peculiar features of operation as influenced by the nature and pressure of the gas, magnetic fields, the circuits employed, etc., are discussed in their relation to the theory and the experimental data.

The writer desires to express his thanks to Professors E. Merritt and F. Bedell for their interest and advice.

PHYSICAL LABORATORY OF CORNELL UNIVERSITY,
April, 1917.